



SPECIFICATION FOR TFT LCD MODULE

CUSTOMER : _____

CUSTOMER MODULE : _____

HG MODEL : HG070WV035

Preliminary Specification

Final Specification

Customer Confirmation column:

Approved by : _____ Dept. : _____ Date : _____

Please return one of the copies of the specification with your signature to us within two weeks after you receive this document. If it is not returned, we will assume that you agree to the entire contents of this specification document.

Designed by	Checked by	Approved by



1.0 General Description

NO.	Item	Specification	Remark
1	LCD size	7.0 inch(Diagonal)	
2	Driver element	a-Si TFT active matrix	
3	Resolution	800 × 3(RGB) × 480	
4	Display mode	Normally White, Transmissive	
5	Dot pitch	0.0642(W) × 0.1790(H) mm	
6	Active area	154.08(W) × 85.92(H) mm	
7	Module size	164.9(W)×100(H)×5.5(D) mm	Note1
8	Surface treatment	Anti-Glare	
9	Color arrangement	RGB-stripe	
10	Display Color	16.7M	
11	Interface	Digital, Paralle24-bit RGB	
12	Weight	TBD(Typ.)	
13	Panel power consumption	0.226W (Typ.)	

Note 1: Refer to Mechanical Drawing.

2. Pin Assignment

2.1. TFT LCD Panel Driving Section

1. FPC Connector is used for the module electronics interface. The recommended model is FH12A-50S-0.5SH manufactured by Hirose.



2. DIAGRAM FOR LCM

由 Autodesk 教育版产品制作

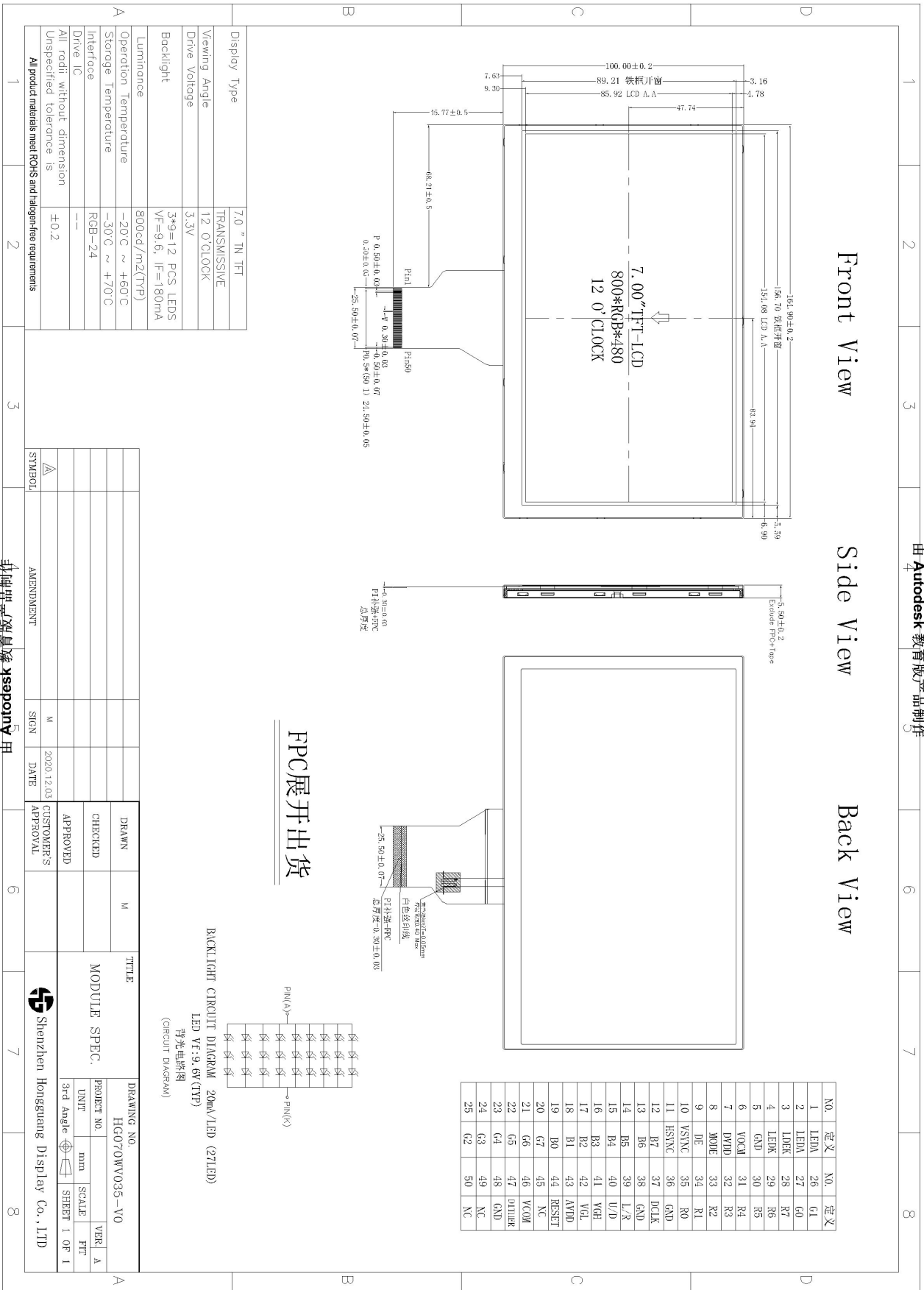

由 Autodesk 教育版产品制作

Front View

Side View

Back View

FPC展开出货

BACKLIGHT CIRCUIT DIAGRAM 20mm/LED (27LED)
LED VF: 9.6V(TYP)
背光电路图
(CIRCUIT DIAGRAM)

Display Type	7.0" TN TFT TRANSMISSIVE
Viewing Angle	120°CLOCK
Drive Voltage	3.3V
Backlight	3*9=12 PCS LEDs VF=9.6, IF=180mA
Luminance	800cd/m2(TYP)
Operation Temperature	-20°C ~ +60°C
Storage Temperature	-30°C ~ +70°C
Interface	RGB-24
Drive IC	--
All radii without dimension	±0.2
Unspecified tolerance is	±0.2
All product materials meet ROHS and halogen-free requirements	

SYMBOL	
AMENDMENT	
SIGN	M
DATE	2020.12.03
CUSTOMER'S APPROVAL	

DRAWN	M
CHECKED	
APPROVED	

TITLE		DRAWING NO.	
MODULE SPEC.		HG070WV035-V0	
PROJECT NO.	UNIT	SCALE	VER. A
	mm		FT
3rd Angle		SHEET 1 OF 1	

非品牌教育版产品 Autodesk 甲

由 Autodesk 教育版产品制作



Pin No	Symbol	I/O	Function	Remark
1	VLED+	P	Power for LED backlight (Anode)	
2	VLED+	P	Power for LED backlight (Anode)	
3	VLED-	P	Power for LED backlight (Cathode)	
4	VLED-	P	Power for LED backlight (Cathode)	
5	GND	P	Power ground	
6	Vcom	I	Common voitage	
7	DVdd	P	Ppwer for Digital Circuit	
8	MODE	I	DE/SYNC mode select	Note 1
9	DE	I	Data input Enable	
10	VS	I	Vertical Sync input	
11	HS	I	Horizontal Sync input	
12	B7	I	Blue data(MSB)	
13	B6	I	Blue data	
14	B5	I	Blue data	
15	B4	I	Blue data	
16	B3	I	Blue data	
17	B2	I	Blue data	
18	B1	I	Blue data	Note 2
19	B0	I	Blue data(LSB)	Note 2
20	G7	I	Green data(MSB)	
21	G6	I	Green data	
22	G5	I	Green data	
23	G4	I	Green data	
24	G3	I	Green data	
25	G2	I	Green data	
26	G1	I	Green data	Note 2



27	G0	I	Green data (LSB)	Note 2
28	R7	I	Red data (MSB)	
29	R6	I	Red data	
30	R5	I	Red data	
31	R4	I	Red data	
32	R3	I	Red data	
33	R2	I	Red data	
34	R1	I	Red data	Note 2
35	R0	I	Red data (LSB)	Note 2
36	GND	P	Power Ground	
37	DCLK	I	Sample clock	Note 3
38	GND	P	Power Ground	
39	L/R	I	Left/right selection	Note 4, 5
40	U/D	I	Up/down selection	Note 4, 5
41	Vgh	P	Gata ON Voltage	
42	Vgl	P	Gata OFF Voltage	
43	Avdd	P	Power for Analog Circuit	
44	RESET	I	Global reset pin	Note 6
45	NC	–	No connection	
46	Vcom	I	Common Voltage	
47	DLTHB		Dithering function	Note 7
48	GND	P	Power Ground	
49	NC	–	No connection	
50	NC	–	No connection	

1:input, 0:output, P:Power

Note 1:DE/SYNC mode select. Normally pull high.

When select DE mode, MODE="1", VS dnd HS must pull high.

When select SYNC mode, MODE="0", DE must be grounded.

Note 2:When input 18 bits PGB data, the two low bits of R, G and B and must be grounded.

Note 3:Data shall be latched at the falling edge of DCLK.



Note 4: Selection of scanning mode

Setting of scan control input		Scanning direction
U/D	L/R	
GND	DVDD	Up to down left to right
GVDD	GND	Down to up right to left
GND	GND	Up to down right to left
DVDD	DVDD	Down to up left to right

Note5: Definition of scanning direction

Refer to the figure as below

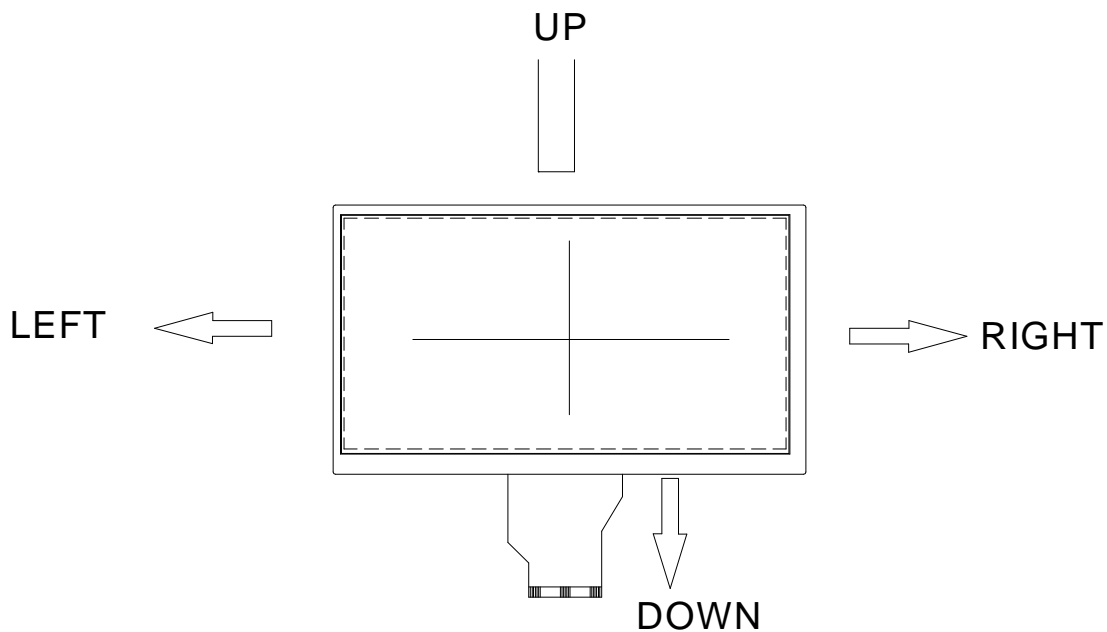

Note 6: Global reset pin Active low to enter reset state Suggest to connect with an RC Reset circuit for stability Normally pull high

Nont 7: Ditherng function enable control normally pull high

When DITHB=" 1" ,Disable intemal dithering function

When DITHB=" 0" ,Enable intemal dithering unction

Nont 8: Reserve for LED power input



3.0 Optical Characteristics

3.1 Absolute Maximum Ratings

Ltem	Symbol	Values		Unit	Remark
		Min	Mas		
Power voltage	DVdd	-0.3	5	V	
	Avdd	6.5	13.5	V	
	Vgh	-0.3	40	V	
	Vgl	-20	0.3	V	
	Vgh_Vgl	_	40	V	
	Operation Temperature	Top	-20	60	°C
Storage Temperature	Tst	-30	70	°C	

Note 1: The absolute maximum rating values of this product are not allowed to be exceeded at any times. Should a module be used with any of the absolute maximum ratings exceeded, the characteristics of the module may not be recovered, or in an extreme case, the module may be permanently destroyed.

3.1.1 Typical Operation Conditions

Ltem	Symbol	Values			Unit	Remark
		Min	Typ	Max		
Power voltage	DVdd	3	3.3	3.6	VV	Note 2
	Avdd	10.2	10.4	10.6	V	
	Vgh	15.3	16	16.7	V	
	Vgl	-7.7	-7	-6.3	V	
	Input signal voltage	Vcom	3.6	3.8	4	V
Input logic high voltage	V _{IH}	0.7DVdd	_	DVdd	V	Note 3
Input logic low voltage	V _{IL}	0	-	0.3DVDD		

Note 1: Be sure to apply DVdd and Vgl to the LCD first, and then apply Vgh.

Note 2: DVdd setting should match the signals output voltage (refer to NOTE 3) of customer's system board.

Note 3: DCLK, HS, VS, RESET, U/D, DE, R0~R7, G0~G7, B0~B7, MODE, DLTHB.

Note 4: Typical VCOM is only a reference value. It must be optimized according to each LCM. Please use VR and base on below application circuit.



3.1.2 Current Consumption

Ltem	Symbol	Values			Unit	Remark
		Min	Typ	Max		
Current for Driver	Igh	—	0.2	1	MA	Vgh=16v
	Igl	—	0.2	1	MA	Vgl=7v
	IDVdd	—	4	10	MA	DVdd=3.3v
	IAVdd	—	20	50	MA	Avdd=10.4v

3.2. Power Sequence

a. Power on:

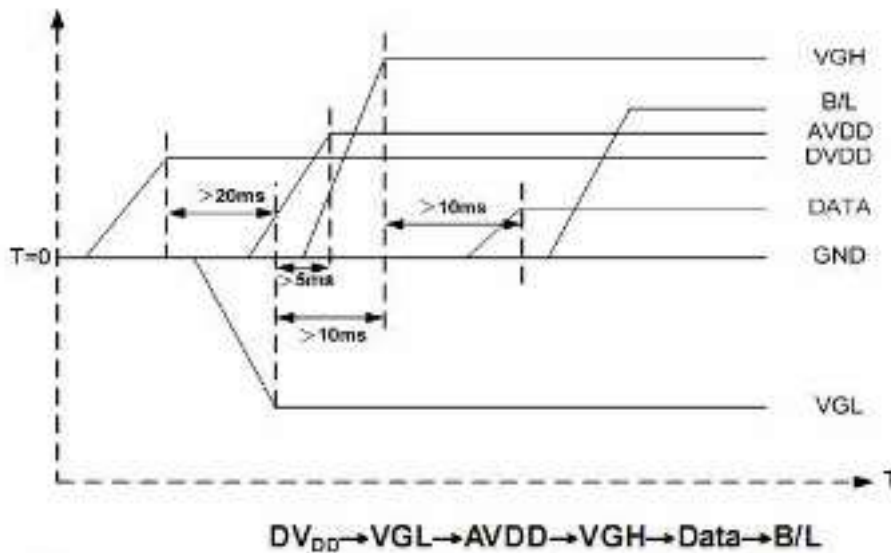

b. Power off:

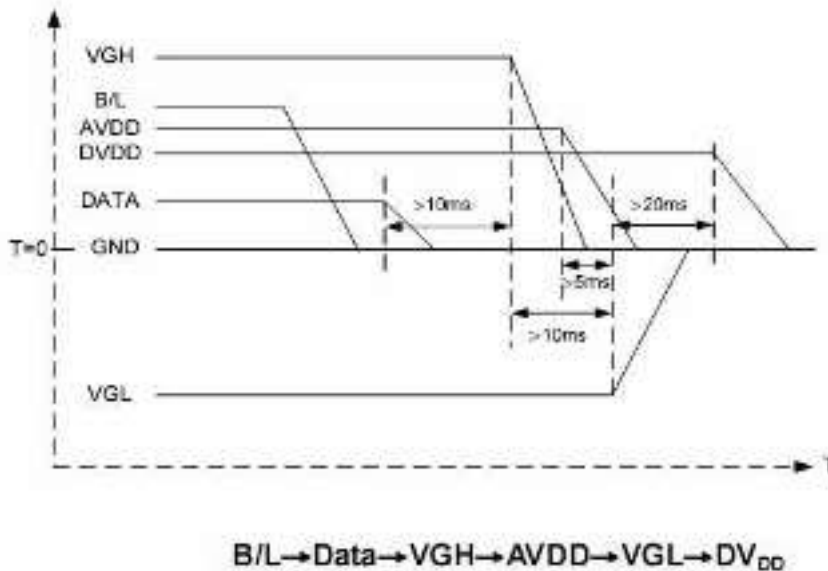

Note: Data include R0-R7, B0-B7, GO-G7, U/D, L/R, DCLK, HS, VS, DE.



3.3 Timing Characteristics

3.3.1 AC Electrical Characteristics

Item	Symbol	Values			Unit	Remark
		Min	Typ	Max		
HS setup time	Thst	8	–	–	ns	
HS hold time	Thhd	8	–	–	ns	
VS setup time	Tvst	8	–	–	ns	
VS hold time	Tvhd	8	–	–	ns	
Data setup time	Tdsu	8	–	–	ns	
Data hole time	Tdhd	8	–	–	ns	
DE setup time	Tesu	8	–	–	ns	
DE hole time	Tehd	8	–	–	ns	
DVdd Power On Slew rate	Tpor	–	–	20	ms	From 0 to 90% DVdd
RESET pulse width	Trst	1	–	–	ms	
DCLK cycle time	Tcoh	20	–	–	ns	
DCLK pulse dully	Tcwh	40	50	60	%	

3.3.2 Input Clock and Data Timing Diagram

3.3.3 Timing						
Item	Symbol	Values			Unit	Remark
		Min	Typ	Max		
Horizontal display Area	thd	–	800	–	DCLK	
DCLK Frequency	fclk	26.4	33.3	46.8	MHZ	
One Horizontal Line	th	862	1056	1200	DCLK	
HS pulse width	thpw	1	–	40	DCLK	
HS Blanking	thp	46	46	46	DCLK	
HS Front Porch	thfp	16	210	354	DCLK	



Ltem	Symbol	Values			Unit	Remark
		Min	Typ	Max		
Vertical Display Area	thd	_	480	_	TH	
VS period time	tv	510	525	650	TH	
VS pulse width	thpw	1	_	20	TH	
VS Blanking	thp	23	23	23	TH	
VS Front porch	tvfp	7	22	147	TH	

3.3.4. Data Input Format

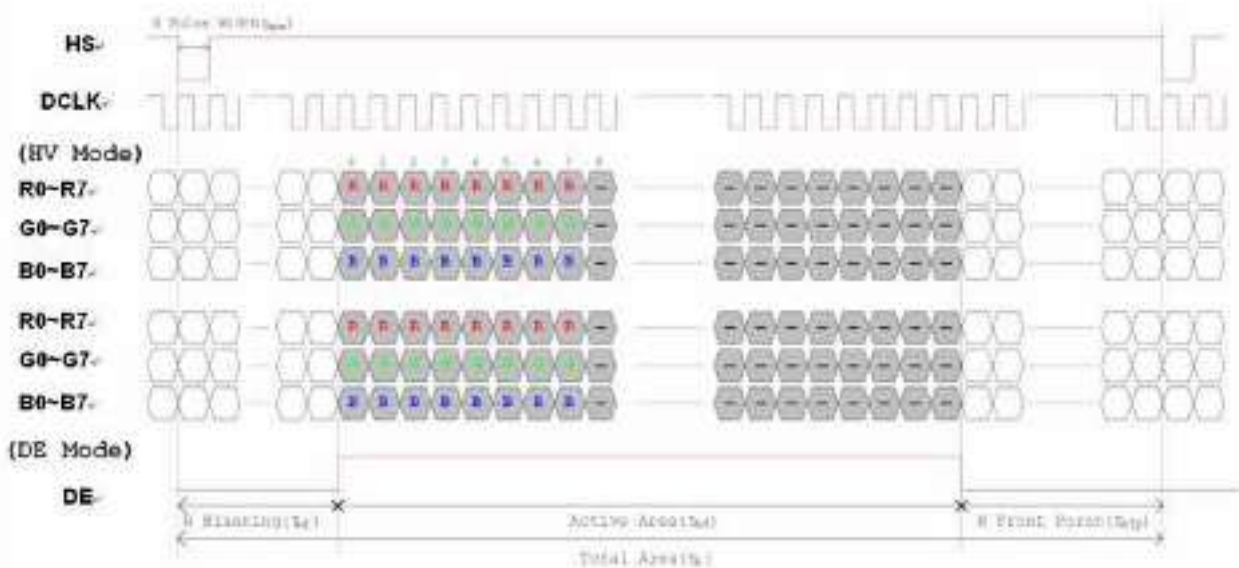

Figure 3. 1 Horizontal input timing diagram.

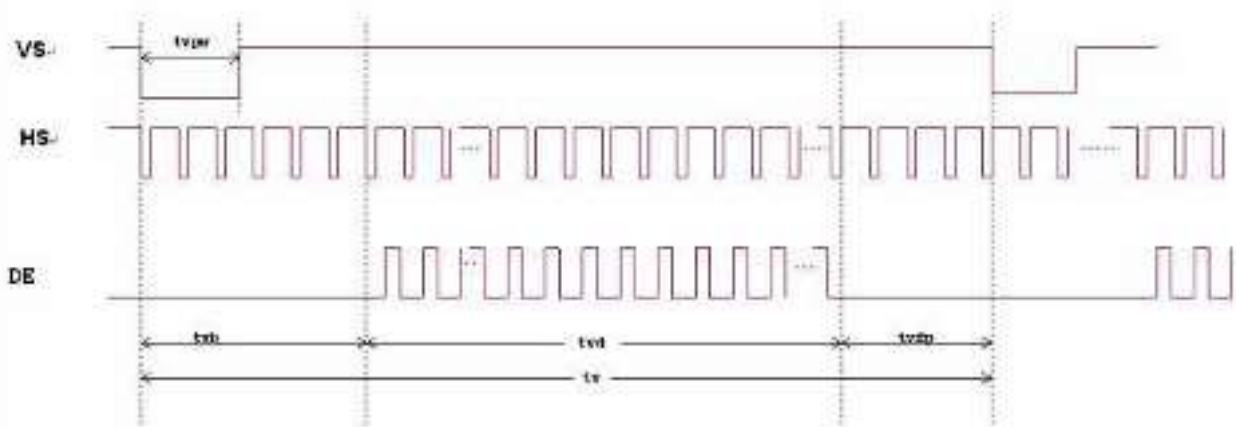

Figure 3. 2 Vertical input timing diagram.



4. Optical Specifications

Note: Base on INNOLUX LCM

Item	Symbol	Condition	Values			Unit	Remark	
			Min	Typ	Max			
Viewing angle (CR ≥ 10)	θ_L	$\Phi=180^\circ$ (9 o'clock)	60	70	—	degree	Note 1	
	θ_R	$\Phi=0^\circ$ (3 o'clock)	60	70	—			
	θ_T	$\Phi=90^\circ$ (12 o'clock)	40	50	—			
	θ_B	$\Phi=270^\circ$ (6 o'clock)	60	70	—			
Response time	T_{on}	Normal $\theta = \Phi = 0$	—	10	20	msec	Note 3	
	T_{off}		—	15	30	msec	Note 3	
Contrast ratio	CR		400	500	—	—	Note 4	
Color Chromaticity	W_x		0.28	0.30	0.33	—	Note 2 Note 5 Note 6	
	W_y		0.29	0.31	0.34	—		
Color Gamut	NTSC		45	50	—	%		
Transmittance	T_r		—	—	5.11	—	%	
LCM Luminance	Y		(I=180mA)	700	800	—	cd/m ²	
Brightness uniformity	B		$\theta = 0$	75	—	—	%	

Test Conditions:

- DVdd=3.3V, the ambient temperature is 25°C.
- The test systems refer to Note 2.

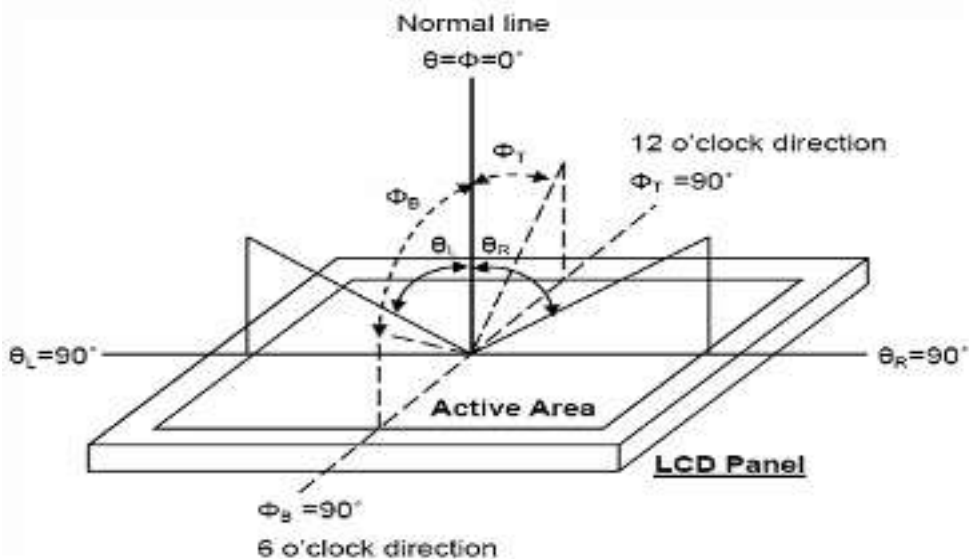

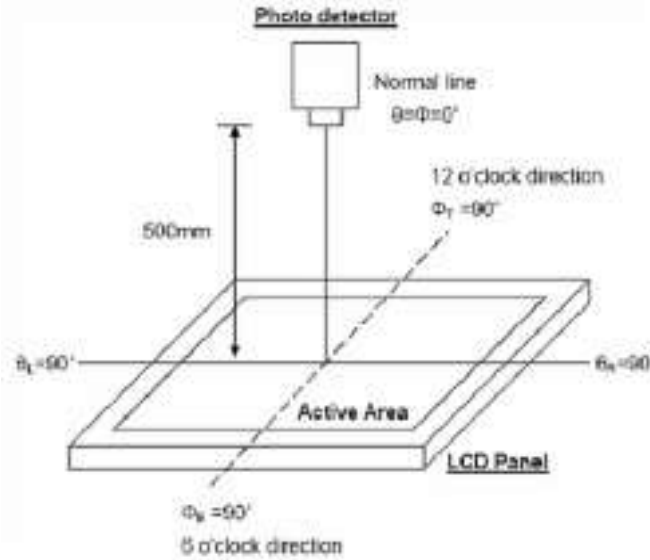

Note 3: Definition of Response time:

The response time is defined as the LCD optical switching time interval between “White state and “Black” state. Rise time, T_r , is the time between photo detector output intensity changed from 90% to 10%. And fall time, T_f , is the time between photo detector output Intensity changed from 10% to 90%.

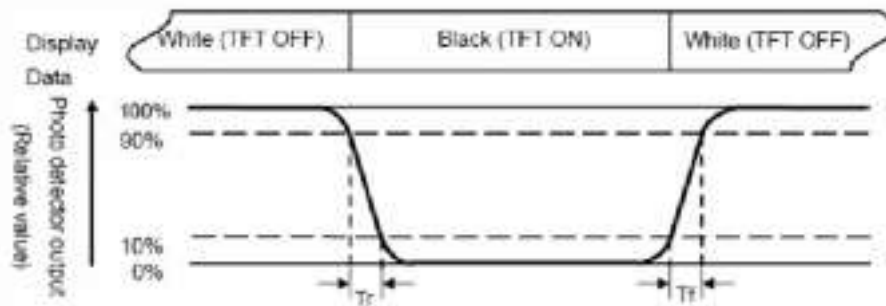

Note 4: Definition of contrast ratio:

The contrast ratio is defined as the following expression.

$$\text{Contrast Ratio (CR)} = \frac{\text{Photo detector output with LCD being "white"}}{\text{Photo detector output with LCD being "black"}}$$

Note 5: White $V_i = V_{i50} \pm 1.5V$

Black $V_i = V_{i50} \pm 2.0V$

“±” means that the analog input signal swings in phase with VCOM signal.

“±” means that the analog input signal swings out of phase with VCOM signal.

The 100% transmission is defined as the transmission of LCD panel when all the input terminals of module are electrical y opened



Note 6: Definition of color chromaticity (CIE 1931)

Color coordinates measured at the center point of LCD

Note 7: Measured at the center area of the panel when all the input terminals of LCD panel are electrically opened. (Reference: Backlight's brightness is 350 nit)

(Min Luminance of 9 points)

(Min Luminance of 9 points)

Note 8: uniformity = $\frac{\text{Min Luminance of 9 points}}{\text{Max Luminance of 9 points}} \times 100\%$

(Max Luminance of 9 points)

Note 9: Definition of brightness uniformity

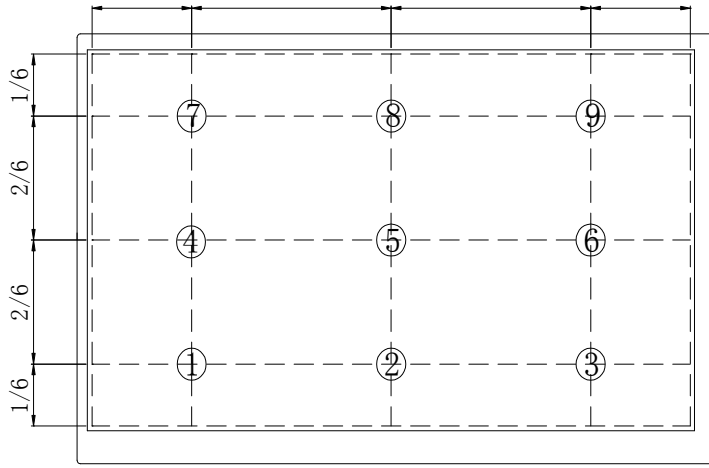

4.2 Measuring Condition

- Measuring surrounding : dark room
- Ambient temperature : $25 \pm 2^\circ\text{C}$
- The measured value of luminance and color coordinate bases HFH's BM-7

4.3 Measuring Equipment

- TOPCON BM-7
- Measuring spot size : field 2°



5.0 Reliability test items

NO	Item	Conditions	Remark
1	High Temperature Storage	Ta=+70°C, 240hrs	
2	Low Temperature Storage	Ta=-30°C, 240hrs	
3	High Temperature Operation	Ta=+60°C, 240hrs	
4	Low Temperature Operation	Ta=-20°C, 240hrs	
5	High Temperature and High Humidity (operation)	Ta=+60°C, 90%RH, 240hrs	
6	Thermal Cycling Test (non operation)	-20°C (0.5hr) → +60°C (0.5hr), 200cycles	
7	Vibration	1. Random: 1.04G, 10-500HZ, X, Y, Z direction 30min/each direction 2. Sweep sine: 1.5G, 5~500Hz, X/Y/Z, 30min/each direction	
8	Shock	100G, 6ms, ±X, ±Y, ±Z 3 time for each direction	JIS C7021, A-10 (Condition A)
9	Vibration (with carton)	Random: 1.04Grms, 10~500Hz, X/Y/Z 45min/each direction Fixed: 5Hz, 1.5Grms, X/Y/Z 45min/each direction	
10	Drop (with carton)	Height: 60cm 1 corner, 3 edges, 6 surfaces	JIS Z0202
11	Electrostatic Discharge	±200V, 200PF, 0Ω1 time/each terminal	

Note: All tests above are practiced at module type.

There is no display function NG issue occurred, All the cosmetic specification is judged before the reliability stress.



6. General Precautions

6.1. Safety

Liquid crystal is poisonous. Do not put it in your mouth. If liquid crystal touches your skin or clothes, wash it off immediately by using soap and water.

6.2. Handling

1. The LCD panel is plate glass. Do not subject the panel to mechanical shock or to excessive force on its surface.
2. The polarizer attached to the display is easily damaged. Please handle it carefully to avoid scratch or other damages.
3. To avoid contamination on the display surface, do not touch the module surface with bare hands.
4. Keep a space so that the LCD panels do not touch other components.
5. Put cover board such as acrylic board on the surface of LCD panel to protect panel from damages.
6. Transparent electrodes may be disconnected if you use the LCD panel under environmental conditions where the condensation of dew occurs.
7. Do not leave module in direct sunlight to avoid malfunction of the ICs.

6.3. Static Electricity

1. Be sure to ground module before turning on power or operating module.
2. Do not apply voltage which exceeds the absolute maximum rating value.

6.4. Storage

1. Store the module in a dark room where must keep at $25\pm 10^{\circ}\text{C}$ and 65%RH or less.
2. Do not store the module in surroundings containing organic solvent or corrosive gas
3. Store the module in an anti-electrostatic container or bag.

6.5. Cleaning

1. Do not wipe the polarizer with dry cloth. It might cause scratch.
2. Only use a soft sloth with IPA to wipe the polarizer, other chemicals might permanent damage to the polarizer.



7.0 Packing form

