



# SPECIFICATION FOR TFT LCD MODULE

CUSTOMER : \_\_\_\_\_

CUSTOMER MODULE : \_\_\_\_\_

HL MODEL :           HG070WS049          

Preliminary Specification

Final Specification

Customer Confirmation column:

Approved by : \_\_\_\_\_ Dept. : \_\_\_\_\_ Data : \_\_\_\_\_

Please return one of the copies of the specification with your signature to us within two weeks after you receive this document. If it is not returned, we will assume that you agree to the entire contents of this specification document.

Designed by	Checked by	Approved by



## Record of Revision

Version	Revise Date	Page	Content
00	2021/12/07	ALL	First issue



## Contents

<b>1. General Specifications</b>	<b>4</b>
<b>2. Pin Assignment</b>	<b>5</b>
<b>3. Operation Specifications</b>	<b>7</b>
3.1. Absolute Maximum Ratings	7
3.2. Typical Operation Conditions	7
3.3. Current Consumption	8
Current for LED Driver	8
3.4. PowerSequence	9
3.5. Signal Timing Characteristics	10
3.5.1. AC Electrical Characteristics	10
3.5.2. DC Electrical Characteristics	12
3.5.3. Data Input Format	13
<b>4. Optical Specifications</b>	<b>14</b>
<b>5. Reliability Test Items</b>	<b>18</b>
<b>6. Mechanical Drawing</b>	<b>19</b>
<b>7. Package Drawing</b>	<b>19</b>
<b>8. General Precautions</b>	<b>20</b>
8.1. Safety	20
8.2. Handling	20
8.3. Static Electricity	20
8.4. Storage	21
8.5. Cleaning	21



## 1. General Specifications

No.	Item	Specification	Remark
1	LCD size	7 inch	
2	Driver element	a-Si TFT active matrix	
3	Resolution	1024 × (RGB) × 600	
4	Display mode	Normally BLACK	
5	Dot pitch	0.1506 (H) x 0.1432 (V) mm	
6	Active area	154.21(W) ×85.92(H) mm	
7	Module size	164.9(W) ×100(H) ×5.5(D) mm	Note 1
8	View direction	ALL	O'Clock
9	Surface treatment	Anti-Glare	
10	Color arrangement	RGB-stripe	
11	Interface	LVDS	
12	Lcm power consumption	3.38W	TYP
13	Drive IC	HX8282A11+HX8696A01	

Note 1: Refer to Mechanical Drawing.



## 2. Pin Assignment

FPC Connector is used for the module electronics interface. The recommended model is FH12A-40S-0.5SH manufactured by Hirose.

Pin. No	Symbol	I/O	Function	Remark
1	VCOM	P	Common Voltage	
2-3	VDD	P	Power Supply	
4	NC	-	No connect	
5	RESET	I	Global reset pin. Active low to enter reset state. Keep VDD during operation. Normally pull high.	
6	STBYB	I	Standby mode, Normally pulled high STBYB=" 1" ,normal operation STBYB=" 0" ,timing controller,source driver will turn off,all output are High-z	
7	GND	P	Ground	
8	NIND0	I	-LVDS differential data input	
9	PIND0	I	+LVDS differential data input	
10	GND	P	Ground	
11	NIND1	I	-LVDS differential data input	
12	PIND1	I	+LVDS differential data input	
13	GND	P	Ground	
14	NIND2	I	-LVDS differential data input	
15	PIND2	I	+LVDS differential data input	
16	GND	P	Ground	
17	NINC	I	-LVDS Differential Clock Input	
18	PINC	I	+LVDS Differential Clock Input	
19	GND	P	Ground	
20	NIND3	I	-LVDS differential data input	
21	PIND3	I	+LVDS differential data input	
22	GND	P	Ground	
23-24	NC	-	No connect	
25	GND	P	Ground	
26	GND	P	Ground	
27	NC	-	No connect	
28	SELB	I	6bit/8bit mode select SHLB=0,LVDS 8BIT SHLB=1,LVDS 6BIT	
29	AVDD	P	Power for Analog Circuit	
30	GND	P	Ground	
31-32	LED-	P	LED Cathode	
33	SHLR	I	Horizontal inversion	Note 1



34	UPDN	I	Vertical inversion	Note 1
35	VGL	P	Gate OFF Voltage	
36	NC	-	No connect	
37	NC	-	No connect	
38	VGH	P	Gate ON Voltage	
39-40	LED+	P	LED Anode	

I: input; O: output; P: Power or Ground(OV).

Notel 1 : Selection of scanning mode

Setting of scan control input		Scanning direction
UPDN	SHLR	
GND	VDD	Up to down, left to right
VDD	GND	Down to up, right to left
GND	GND	Up to down, right to left
VDD	VDD	Down to up, left to right

Refer to the figure as below:

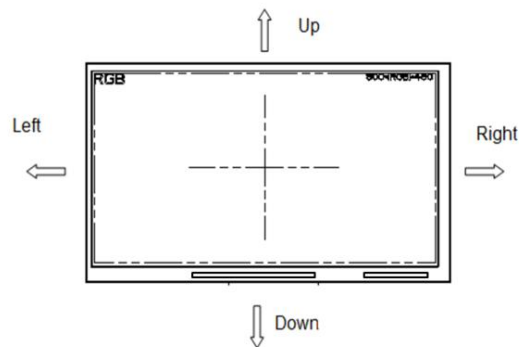



## 3. Operation Specifications

### 3.1. Absolute Maximum Ratings

(Note 1)

Item	Symbol	Values		Unit	Remark
		Min.	Max.		
Power voltage	VDD	3.0	3.6	V	VSS=0V, TA=25°C
Operation Temperature	T <sub>OP</sub>	-20	70	°C	
Storage Temperature	T <sub>ST</sub>	-30	80	°C	

Note1 : The absolute maximum rating values of this product are not allowed to be exceeded at any times. Should a module be used with any of the absolute maximum ratings exceeded, the characteristics of the module may not be recovered, or in an extreme case, the module may be permanently destroyed.

### 3.2. Typical Operation Conditions

Test condition: GND=0V, TA=25 °C

Item	Symbol	Values			Unit	Remark
		Min.	Typ.	Max.		
Power voltage	VDD	3.0	3.3	3.6	V	
	VGH	17	18	19	V	
	VGL	-6.6	-6	-5.4	V	
	AVDD	9.4	9.6	9.8	V	
	VCOM	3.1	3.2	3.3	V	
Input logic high voltage	V <sub>IH</sub>	0.7 V <sub>DD</sub>	-	V <sub>DD</sub>	V	
Input logic low voltage	V <sub>IL</sub>	0		0.3 V <sub>DD</sub>	V	



## 3.3. Current Consumption

### Current for LED Driver

Item	Symbol	Values			Unit	Remark
		Min.	Typ.	Max.		
Voltage for LED Backlight	$V_L$	7.4	9	10.6	V	Note 1
Current for LED Backlight	$I_L$	-	180	-	mA	
LED life time	-	20,000	-	-	Hr	Note 2

Note1:  $V_L=9V$ ,  $I_L=180mA$  (Backlight circuit: 3series connection, 9 parallel connection), the ambient temperature is  $25^{\circ}C$ .

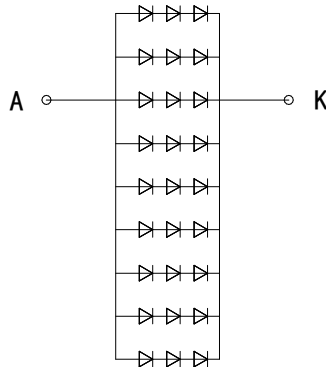

Fig. 3-1 LED test circuit diagram

Note 2: The “LED life time” is defined as the module brightness decrease to 50% original brightness at  $T_a=25^{\circ}C$  and 1/2 rated current . The LED lifetime could be decreased if operating  $I_L$  is larger than 180 mA.





### 3.4. PowerSequence

Power on:

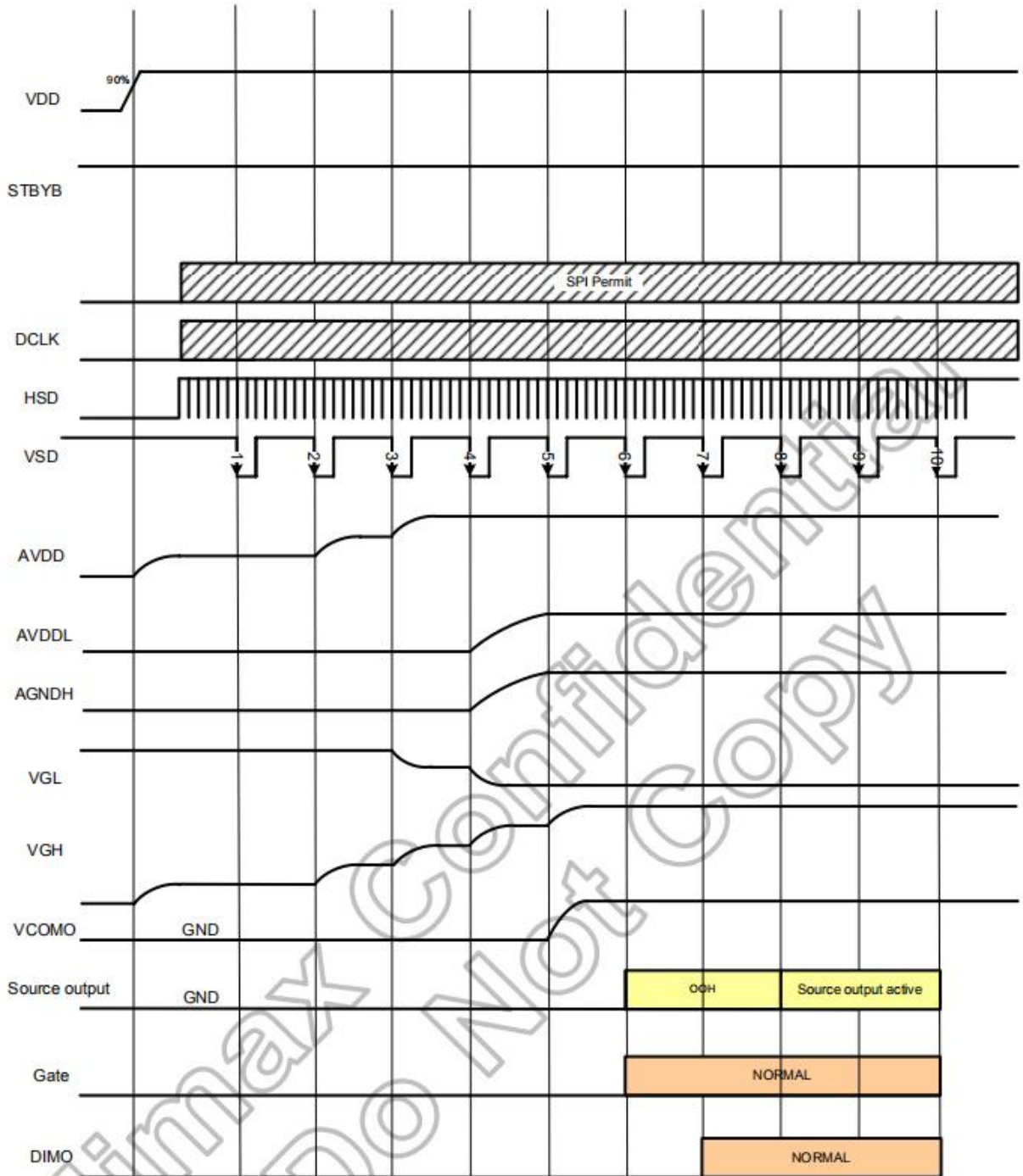



## Power off:

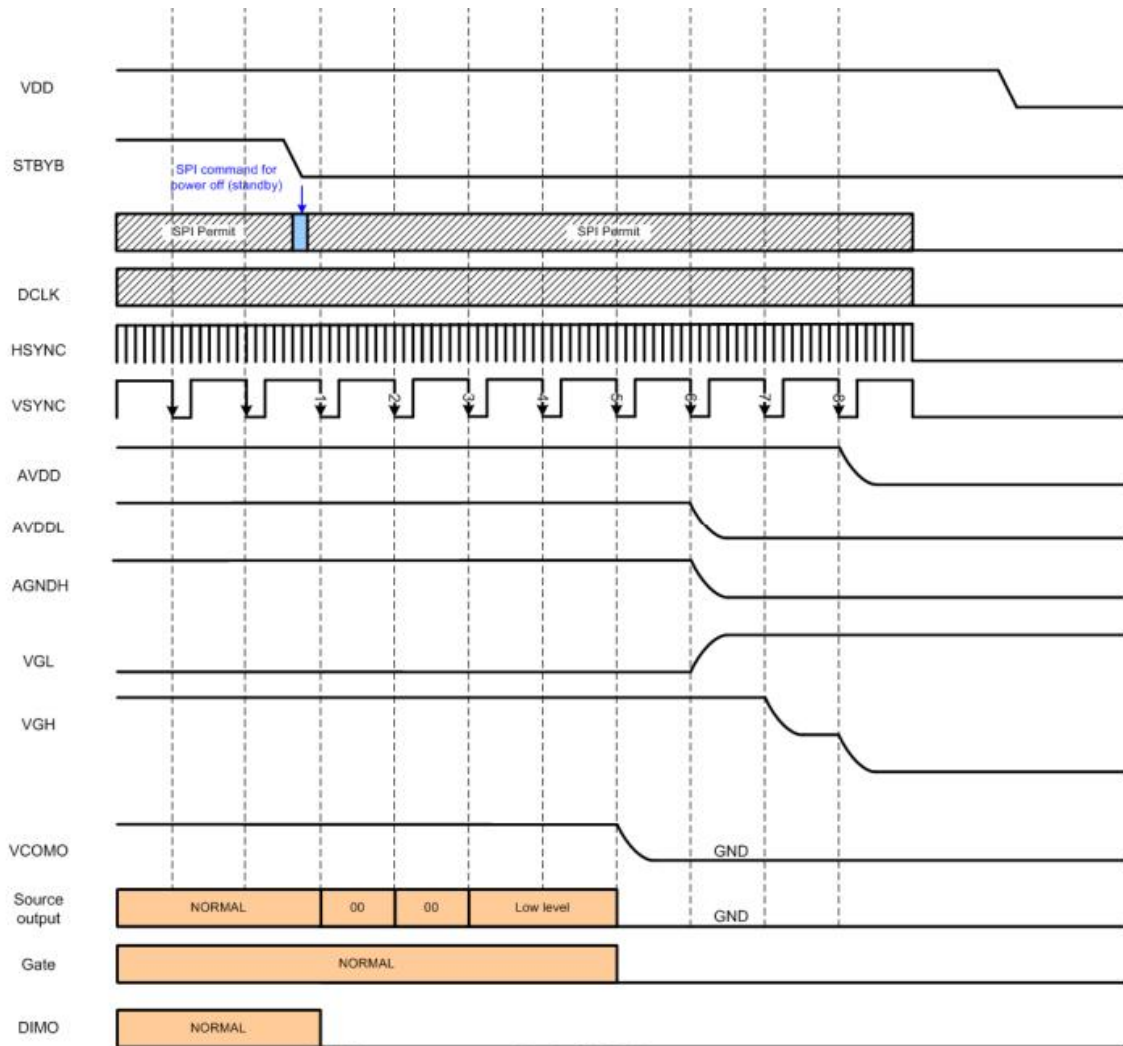

## 3.5. Signal Timing Characteristics

### 3.5.1. AC Electrical Characteristics

Parameter	Symbol	Spec.			Unit	Condition
		Min.	Typ.	Max.		
Clock frequency	$R_{XFCLK}$	20	-	71	MHz	-
Input data skew margin	$T_{RSKM}$	500	-	-	pS	$ V_{ID} =400mV$ $R_{XVCM}=1.2V$ $R_{XFCLK}=71MHz$
Clock high time	$T_{LVCH}$	-	$4/(7 * R_{XFCLK})$	-	ns	-
Clock low time	$T_{LVCL}$	-	$3/(7 * R_{XFCLK})$	-	ns	-
PLL wake-up time	$T_{emPLL}$	-	-	150	$\mu s$	-

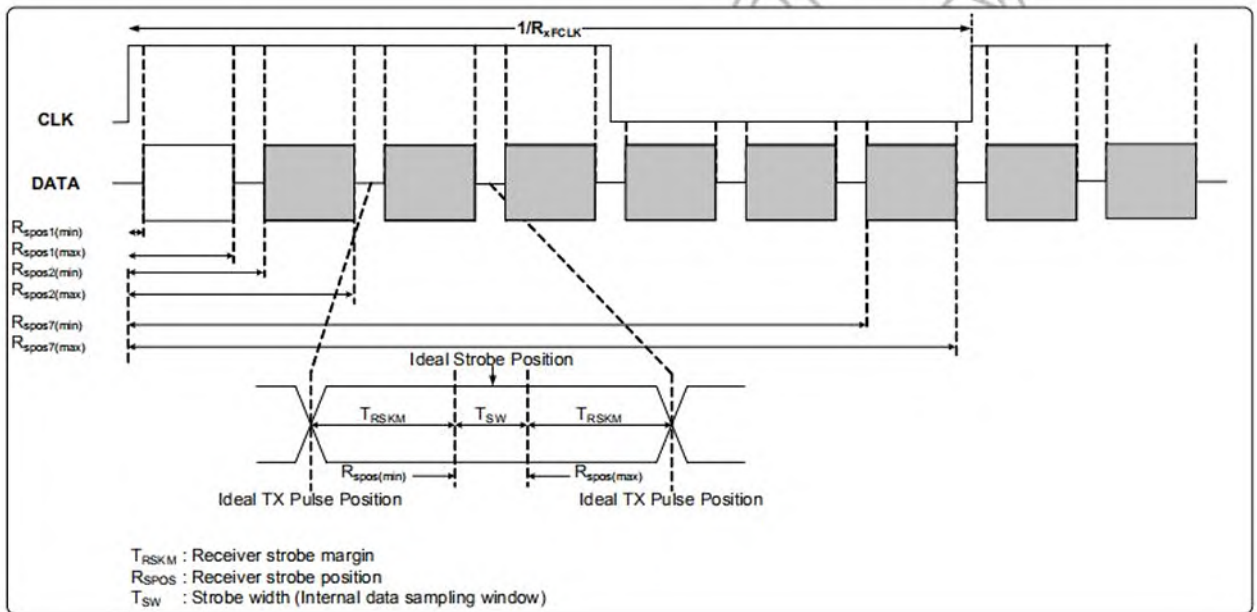
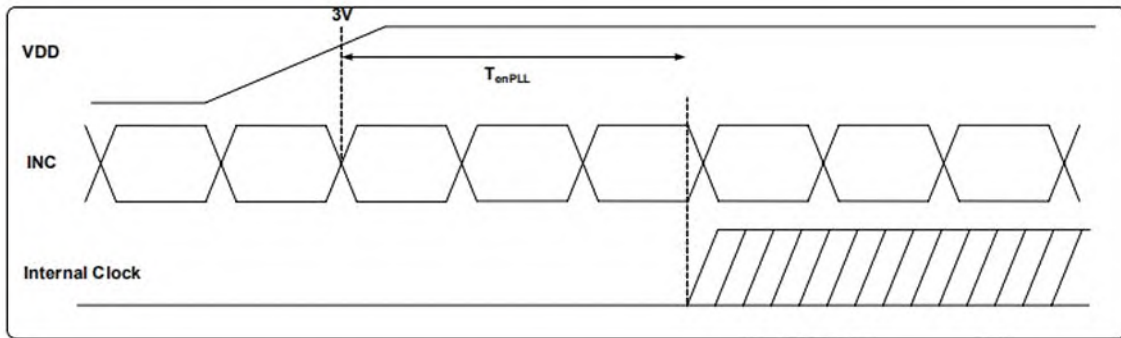
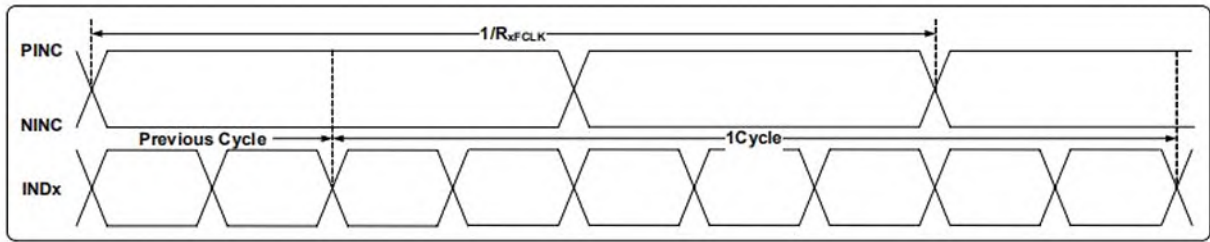



## 3.5.2. DC Electrical Characteristics

Parameter	Symbol	Spec.			Unit	Condition
		Min.	Typ.	Max.		
Differential input high Threshold voltage	$R_{XVTH}$	-	-	+0.1	V	$R_{XVCM}=1.2V$
Differential input low threshold voltage	$R_{XVTL}$	-0.1	-	-	V	
Input voltage range (singled-end)	$R_{XVIN}$	0	-	$VDD-1.2+ V_{ID} /2$	V	-
Differential input common Mode voltage	$R_{XVCM}$	$ V_{ID} /2$	-	$VDD-1.2$	V	-
Differential input voltage	$ V_{ID} $	0.2	-	0.6	V	-
Differential input leakage Current	$R_{V_{XIZ}}$	-10	-	+10	$\mu A$	-
LVDS Digital Operating Current	$I_{ddlvds}$	-	15	30	mA	Fclk=65MHz, VDD=3.3V
LVDS Digital Stand-by Current	$I_{stlvds}$	-	10	50	$\mu A$	Clock & all Functions are stopped

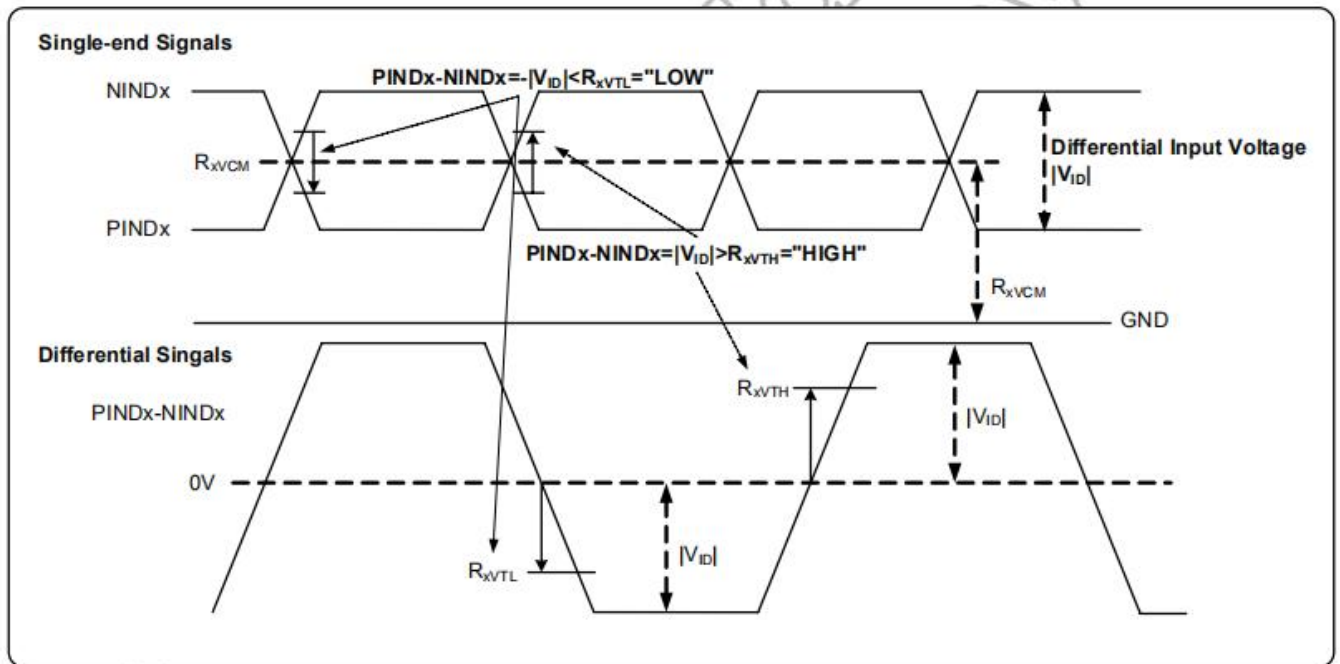



### 3.5.3. Data Input Format

#### 6-bit LVDS input:

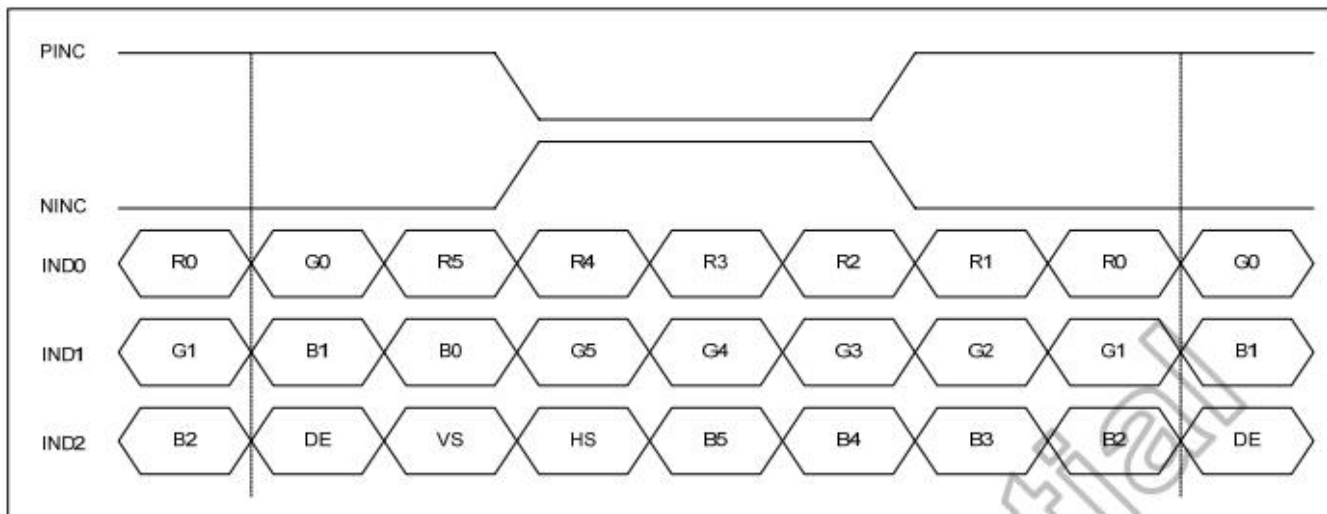

#### 8-bit LVDS input:

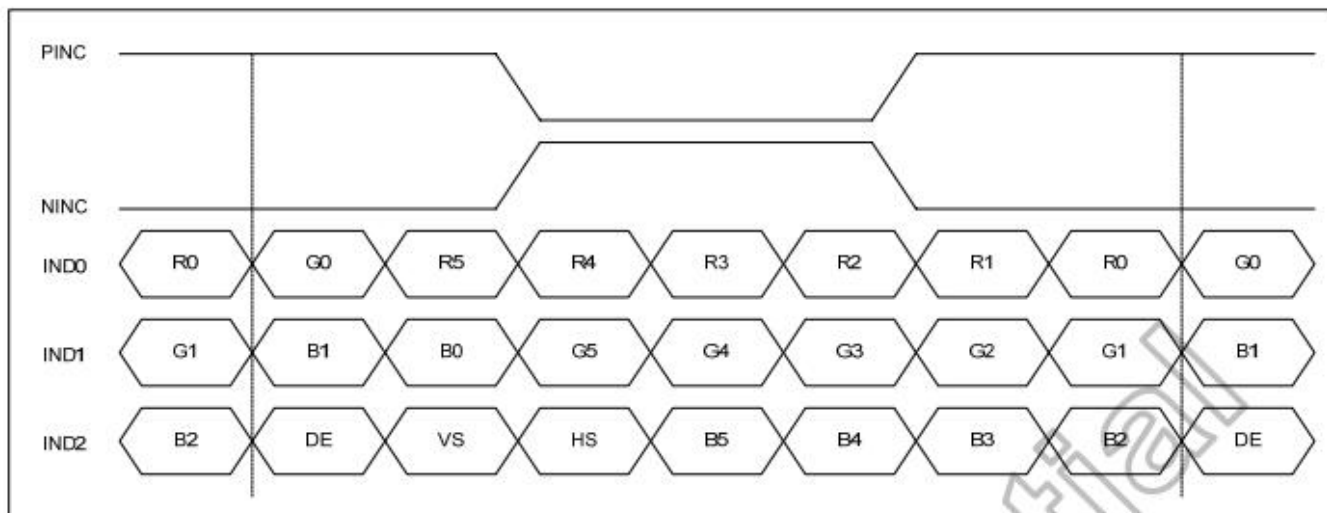



## 4. Optical Specifications

Item	Symbol	Condition	Values			Unit	Remark
			Min.	Typ.	Max.		
Viewing angle (CR≥ 10)	$\theta_L$	$\Phi=180^\circ$ (9 o'clock)	-	85	-	degree	Note 1
	$\theta_R$	$\Phi=0^\circ$ (3 o'clock)	-	85	-		
	$\theta_T$	$\Phi=90^\circ$ (12 o'clock)	-	85	-		
	$\theta_B$	$\Phi=270^\circ$ (6 o'clock)	-	85	-		
Response time	$T_{ON}$	Normal $\theta=\Phi=0^\circ$	-	15	15	msec	Note 3
	$T_{OFF}$		-	15	25	msec	Note 3
Contrast ratio	CR		-	800	-	-	Note 4
Color chromaticity	$W_X$		0.240	0.290	0.340	-	Note 2
	$W_Y$		0.250	0.300	0.350	-	Note 5 Note 6
NTSC				50		%	
Luminance	L		450	480	-	cd/m <sup>2</sup>	Note 6
Luminance uniformity	$Y_U$		70	80	-		Note 7

The test systems refer to Note 2.



Note 1: Definition of viewing angle range

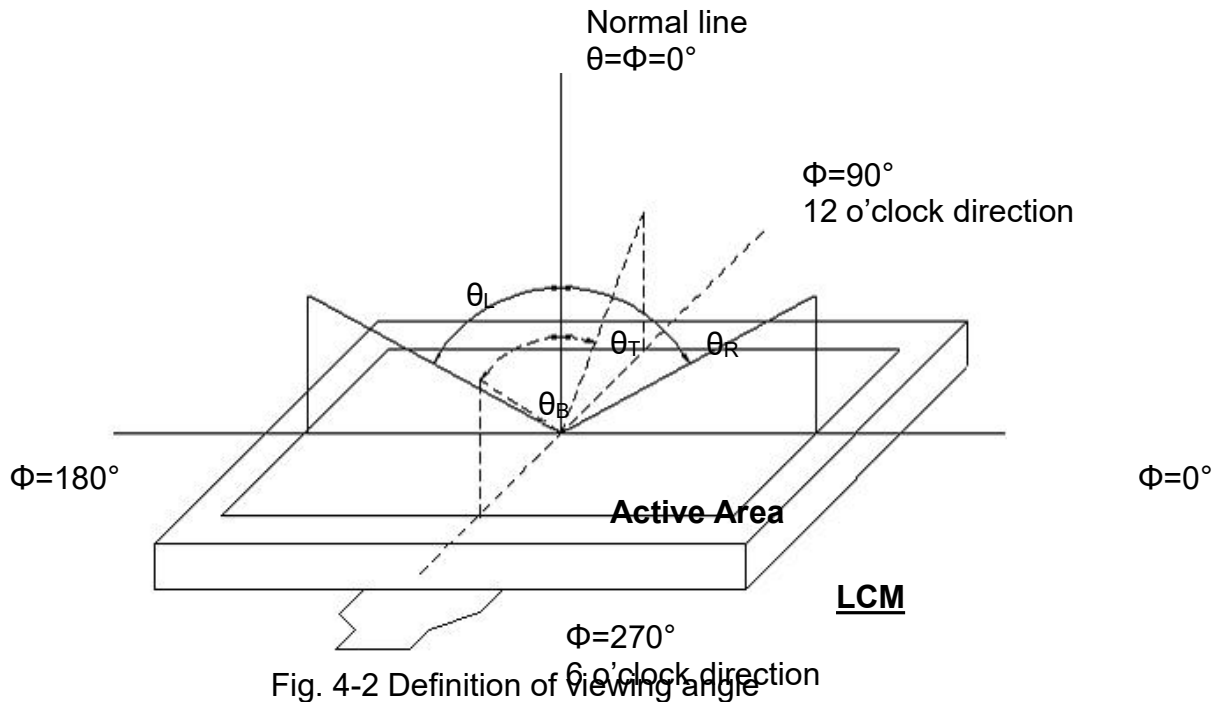

Fig. 4-2 Definition of viewing angle

Note 2: Definition of optical measurement system.

The optical characteristics should be measured in dark room. After 30 minutes operation, the optical properties are measured at the center point of the LCD screen. (Viewing angle is measured by ELDIM-EZ contrast/Height :1.2mm, Response time is measured by Photo detector TOPCON BM-7, other items are measured by BM-5A/ Field of view:  $1^\circ$  /Height: 500mm.) or CA-210.

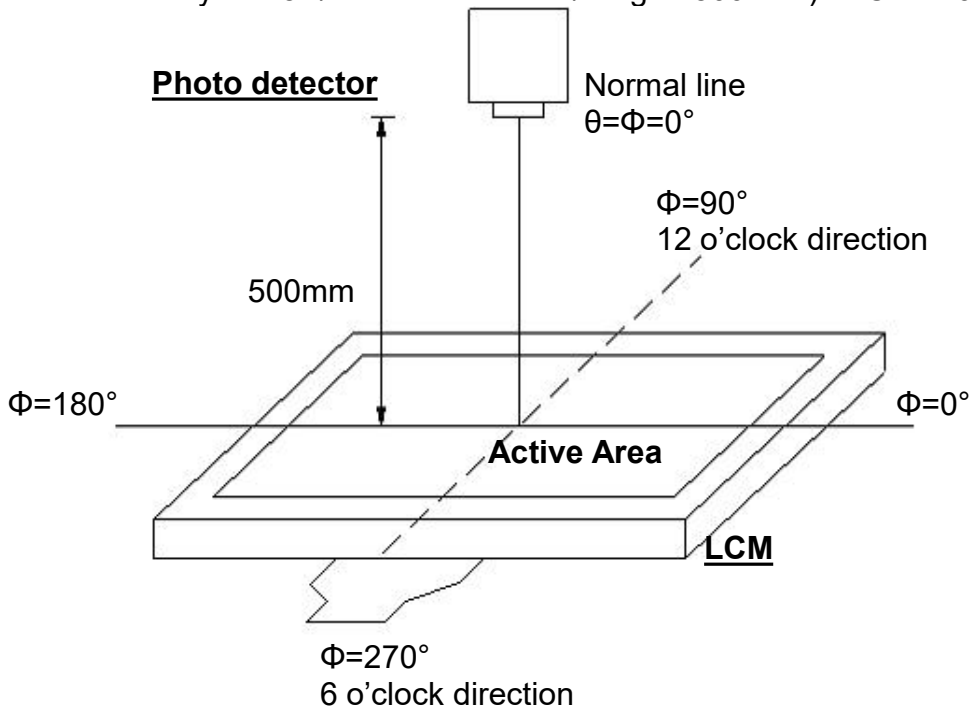

Fig. 4-3 Optical measurement system setup



### Note 3: Definition of Response time

The response time is defined as the LCD optical switching time interval between "White" state and "Black" state. Rise time ( $T_{ON}$ ) is the time between photo detector output intensity changed from 90% to 10%. And fall time ( $T_{OFF}$ ) is the time between photo detector output intensity changed from 10% to 90%.

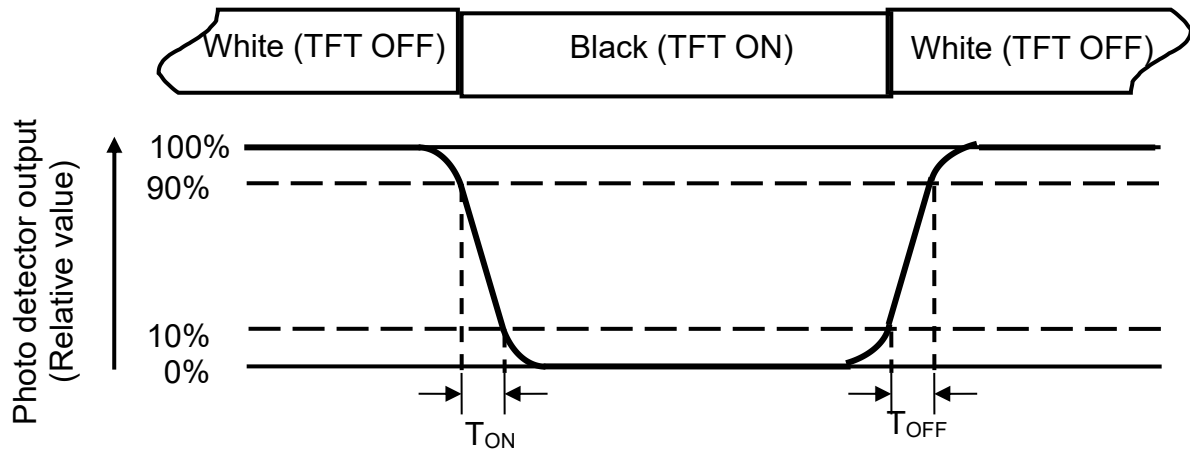

Fig. 4-4 Definition of response time

### Note 4: Definition of contrast ratio

$$\text{Contrast ratio (CR)} = \frac{\text{Luminance measured when LCD on the "White" state}}{\text{Luminance measured when LCD on the "Black" state}}$$

### Note 5: Definition of color chromaticity (CIE1931)

Color coordinates measured at center point of LCD.

Note 6: All input terminals LCD panel must be ground while measuring the center area of the panel. The LED driving condition is  $I_L=180\text{mA}$ .

### Note 7: Definition of Luminance Uniformity

Active area is divided into 9 measuring areas(Refer to Fig. 4-4).

Every measuring point is placed at the center of each measuring area.





$$\text{Luminance Uniformity (Yu)} = \frac{B_{min}}{B_{max}}$$

L-----Active area length      W----- Active area width

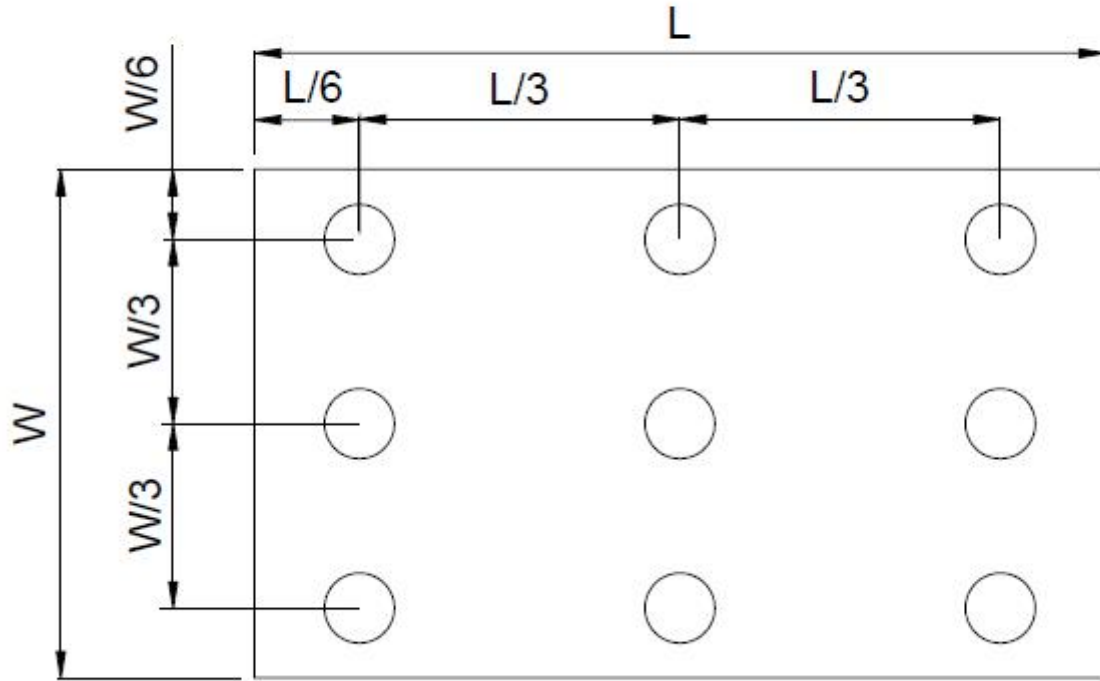

Fig. 4-4 Definition of measuring points

$B_{MAX}$ : The measured maximum luminance of all measurement position.

$B_{MIN}$ : The measured minimum luminance of all measurement position.



## 5. Reliability Test Items

Item	Test Conditions	Criterion
High Temperature Storage	Ta = 80°C                      120hrs	A,B,C,D,E
Low Temperature Storage	Ta = -30°C                      120hrs	A,B,C,D,E
High Temperature Operation	Ts = 70°C                      120hrs	A,B,C,D,E
Low Temperature Operation	Ta =-20°C                      120hrs	A,B,C,D,E
Operate at High Temperature and Humidity	+60°C, 90%RH                      120hrs	A,B,C,D,E
Thermal Shock(non operation)	-20°C/30 min ~ +60°C/30 min for a total 30 cycles, Start with cold temperature and end with high temperature.	A,B,C,D,E
Vibration Test	Sweep:10Hz~55Hz~10Hz 2G 2 hours for each direction of X. Y. Z. (6 hours for total)	A,B,C,D,E
Package Vibration Test	Random Vibration : 0.015G*G/Hz from 5-200HZ, -6dB/Octave from 200-500HZ 2 hours for each direction of X. Y. Z. (6 hours for total)	A,B,C,D,E
Package Drop Test	Height:60 cm 1 corner, 3 edges, 6 surfaces	A,B,C,D,E
Electro Static Discharge	Contact=+/-4KV, Air=+/-8KV,(R=330R,C=150pF), 1 sec,5point,10times/point;	A,B,C,D,E

※Criterion:

A.LCM each function is OK,.

B.LCM appearance inspection without abnormalities (Including scratch, damage, corrosion and serious deformation)

C.LCM brightness above the Min. value of Spec.

D. Luminance uniformity above the Min. value of Spec.

E. Color chromaticity within tolerance range



## 6. Mechanical Drawing

由 Autodesk 教育版产品制作

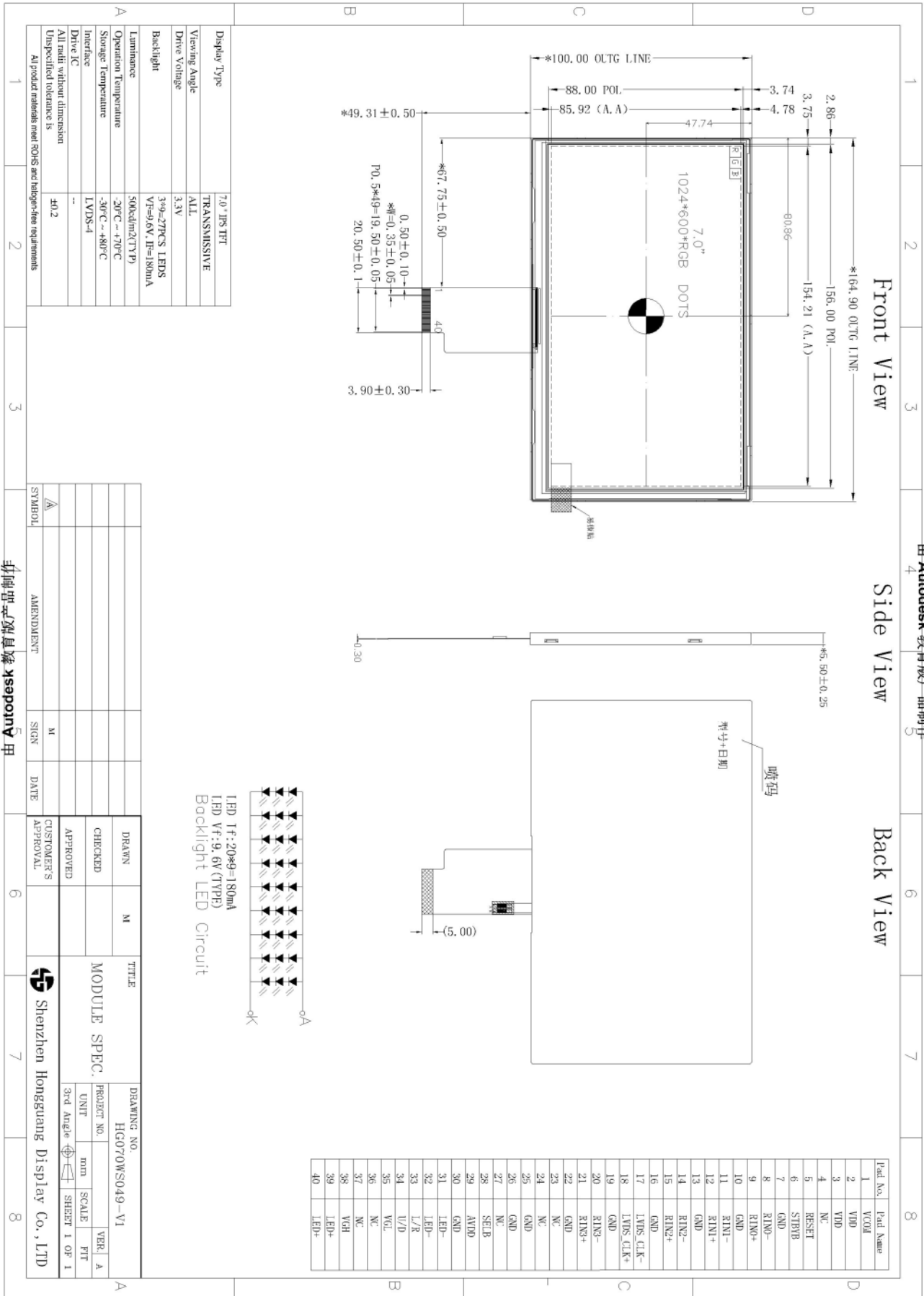

由 Autodesk 教育版产品制作

由 Autodesk 教育版产品制作



## 7. Package Drawing

TBD

## 8. General Precautions

### 8.1. Safety

Liquid crystal is poisonous. Do not put it in your mouth. If liquid crystal touches your skin or clothes, wash it off immediately by using soap and water.

### 8.2. Handling

1. The LCD panel is plate glass. Do not subject the panel to mechanical shock or to excessive force on its surface.
2. The polarizer attached to the display is easily damaged. Please handle it carefully to avoid scratch or other damages.
3. To avoid contamination on the display surface, do not touch the module surface with bare hands.
4. Keep a space so that the LCD panels do not touch other components.
5. Put cover board such as acrylic board on the surface of LCD panel to protect panel from damages.
6. Transparent electrodes may be disconnected if you use the LCD panel under environmental conditions where the condensation of dew occurs.
7. Do not leave module in direct sunlight to avoid malfunction of the ICs.

### 8.3. Static Electricity

1. Be sure to ground module before turning on power or operating module.
2. Do not apply voltage which exceeds the absolute maximum rating value.



## 8.4. Storage

1. Store the module in a dark room where must keep at  $25\pm 10^{\circ}\text{C}$  and 65%RH or less.
2. Do not store the module in surroundings containing organic solvent or corrosive gas.
3. Store the module in an anti-electrostatic container or bag.

## 8.5. Cleaning

1. Do not wipe the polarizer with dry cloth. It might cause scratch.
2. Only use a soft sloth with IPA to wipe the polarizer, other chemicals might permanent damage to the polarizer.