



SPECIFICATION FOR TFT LCD MODULE

CUSTOMER : _____

CUSTOMER MODULE : _____

HL MODEL : HG040HS002T01

Preliminary Specification

Final Specification

Customer Confirmation column:

Approved by : _____ Dept. : _____ Data : _____

Please return one of the copies of the specification with your signature to us within two weeks after you receive this document. If it is not returned, we will assume that you agree to the entire contents of this specification document.

Designed by	Checked by	Approved by



CONTENTS

	<u>Page</u>
	<u>No.</u>
1. DOCUMENT REVISION HISTORY	3
2. GENERAL DESCRIPTION	4
3. MECHANICAL SPECIFICATIONS	4
4. INTERFACE SIGNALS	5
5. ABSOLUTE MAXIMUM RATINGS	7
6. ELECTRICAL SPECIFICATIONS	7
7. OPTICAL CHARACTERISTICS	8
8. TIMING CHARACTERISTICS	11
9. RELIABILITY TEST ITEM	12
10. SUGGESTIONS FOR USING LCD MODULES	15
11. PACKING(REFERENCE ONLY)	16



1. Document revision history :

DOCUMENT REVISION	DATE	DESCRIPTION	PREPARED BY	APPROVED BY
A	2021.11.30	First Release.	ZGL	
B	2022.02.14	Alter the flexibility of FPC on TFT Screen, reinforcement increases the mounting handle	ZGL	
C	2022.03.25	Alter the shape of the mounting handle	ZGL	
D	2020.06.24	The FPC on the TFT screen is lengthened by 10mm , conductive double-sided adhesive is added, and the mounting handle is changed	ZGL	



2. General Description

- 3.95”(diagonal), 480 x3 RGB x480dots, 16.7M colors, Transmissive, TFT LCD module.
- Viewing Direction: free viewing direction
- **Driving IC: ST7701S**
- **mipi Interface**
- Logic voltage: 2.8V (typ.).
- With touch panel.

3. Mechanical Specifications

The mechanical detail is shown in Fig. 1 and summarized in Table 1 below.

Table 1

Parameter		Specifications	Unit
主屏 Color TFT 480 x3 RGB x480	Outline dimensions	83.8(W) X83.8(H) x3.18(D)	mm
	TP view area	72.26(W) x70.58(H)	mm
	TP active area	-----	mm
	LCD active area	71.86(W) x70.18(H)	mm
	Display format	480 x3 RGB x480	dots
	Color configuration	RGB stripes	-
	Dot pitch	149.7(RGB)(W) x 146.2(H)	um
Weight		TBD	grams



4. Interface signals

Figure 1: Outline Drawing

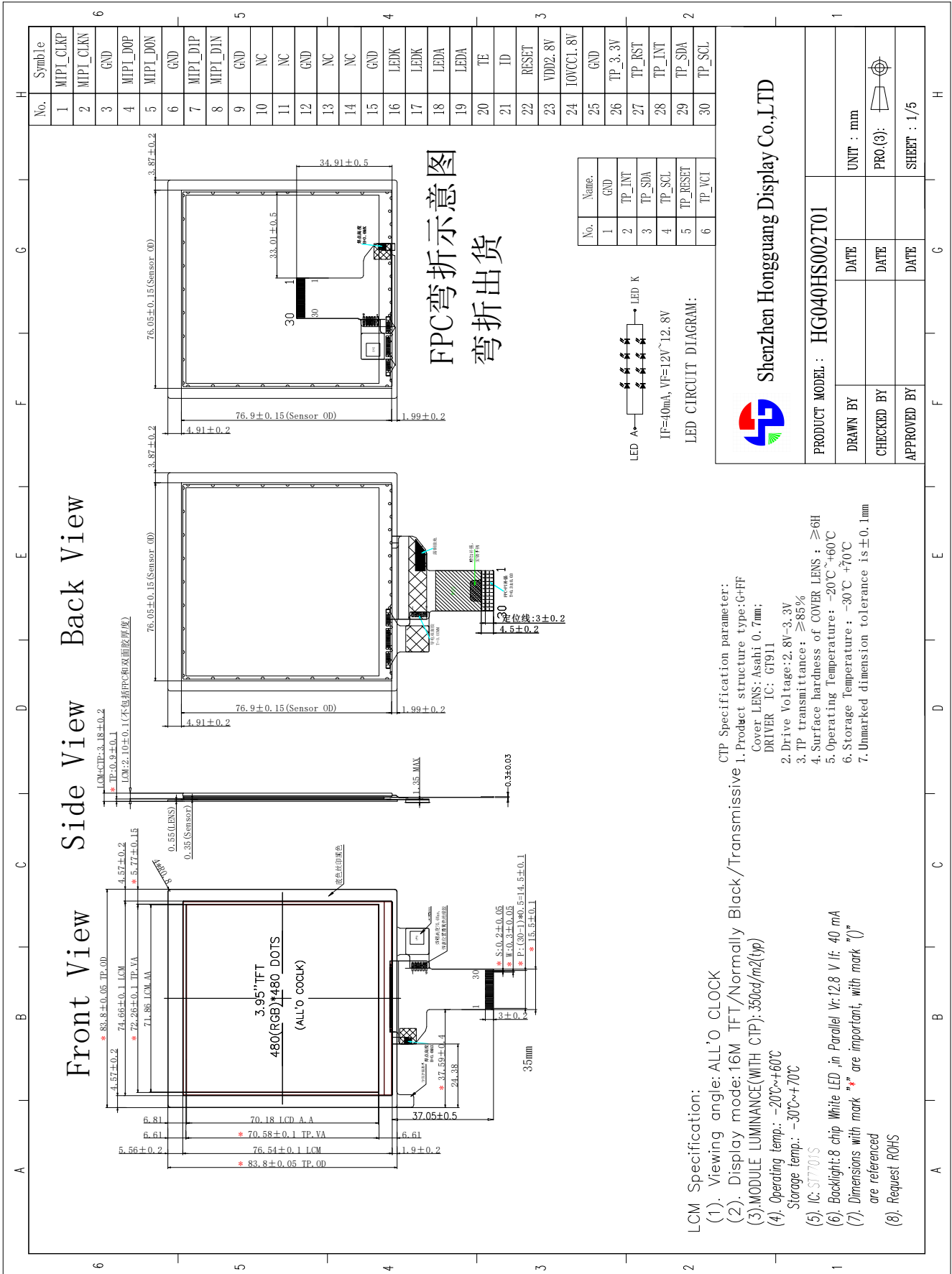



Table 2: Pin assignment

LCM

Pin No.	Symbol	Description
1	MIPI_CLKP	clock Lane positive-end input pin/ (Clock pin)
2	MIPI_CLKN	clock Lane negative-end input pin/ (Clock pin)
3	GND	Ground
4	MIPI_D0P	data Lane 0 positive-end input/output pin/
5	MIPI_D0N	data Lane 0 negative-end input/output pin/
6	GND	Ground
7	MIPI_D1P	data Lane 1 positive-end input/output pin/
8	MIPI_D1N	data Lane 1 negative-end input/output pin/
9	GND	Ground
10, 11	NC	No Connection
12	GND	Ground
13, 14	NC	No Connection
15	GND	Ground
16, 17	LEDK	Cathode of LED
18, 19	LEDA	Anode of LED
20	TE	Output a frame head pulse signal
21	ID	LCM ID PIN
22	RESET	LCM reset pin
23	VDD2.8V	Analog power supply 2.8V
24	IOVCC1.8V	Analog power supply 1.8V
25	GND	Ground
26	TP_3.3V	TP Power Supply(2.8V or 3.3V)
27	TP_RST	I2C TP reset pin
28	TP_INT	Interrupt for CTP
29	TP_SDA	IIC data for CTP
30	TP_SCL	IIC clock for CTP



5. Absolute Maximum Ratings

5.1 Electrical Maximum Ratings – for IC Only

Table 3: Electrical Maximum Ratings – for IC

Parameter	Symbol	Min.	Max.	Unit	Note
Power supply voltage (VDD)	VDD	-0.3	+3.6	V	1
Power supply voltage (IOVCC)	IOVCC	-0.3	+3.6	V	1

Note:

- 1.IOVCC,VCI, GND must be maintained.
- 2.The modules may be destroyed if they are used beyond the absolute maximum ratings.

5.2 Environmental Condition

Table 4

Item	Operating temperature (Topr)		Storage temperature (Tstg) (Note 1)		Remark
	Min.	Max.	Min.	Max.	
Ambient temperature	-20°C	+60°C	-30°C	+70°C	Dry
Humidity (Note 1)	80% max. RH for Ta ≤ 40C < 50% RH for 40C < Ta Maximum operating temperature				No condensation

Note 1: Product cannot sustain at extreme storage conditions for long time.

6. Electrical Specifications

Typical Electrical Characteristics

At Ta = 25 °C, VCI = 2.6V to 3.3V, IOVCC= 1.65V to 3.3V GND=0V.

Table 5

Parameter	Symbol	Conditions	Min.	Typ.	Max.	Unit
Supply voltage (analog)	VCI-GND		2.6	2.8	3.3	V
Supply voltage (logic)	IOVDD-GND		1.65	1.8	3.3	V
Supply current (Logic & LCD)	ICC	VCI=2.8V				mA
Supply voltage of white LED backlight	VLED =V(BL+)- V(BL-)	Forward current =40mA Number of LED dies = 8	11.2	12	12.8	V
Luminance (on the module surface)				350	-	cd/m ²
Life	LED				50000	hour



Life	TP	a. 点击测试: 20 万次每点, 15 GF, 每秒 1 次, 5 点: [1 号样品: 4 个角+1 中心, 2 号样品: 4 中段+1 中心] b. 按压测试: 100N;速度为 10 mm/min, 1 秒		10000 00		hour
------	----	--	--	-------------	--	------

7. Optical Characteristics

Table 7: Optical specifications

Items		Symbol	Condition	Specifications			Unit
				Min.	Typ.	Max.	
Contrast Ratio		CR		640	800	-	-
Response Time		T _R		-	12	16	ms
		T _F		-	14	20	ms
Chromaticity	Red	X _R					-
		Y _R					-
	Green	X _G					-
		Y _G					-
	Blue	X _B					-
		Y _B					-
White	X _w					-	
	Y _w					-	
Viewing angle	Hor.	φ1(3 o'clock)	Center CR≥10	-	80	-	deg.
		φ2(9 o'clock)		-	80	-	
	Ver.	θ2(12 o'clock)		-	80	-	
		θ1(6 o'clock)		-	80	-	
NTSC ratio				55	60		

Note 1: Definition of Contrast Ratio (CR):

The contrast ratio can be calculated by the following expression.

$$\text{Contrast Ratio (CR)} = L_{63} / L_0$$

L₆₃: Luminance of gray level 63

L₀: Luminance of gray level 0

$$\text{CR} = \text{CR} (10)$$

CR (X) is corresponding to the Contrast Ratio of the point X at Figure in Note 5.

Note 2: Definition of Response Time (TR, TF):

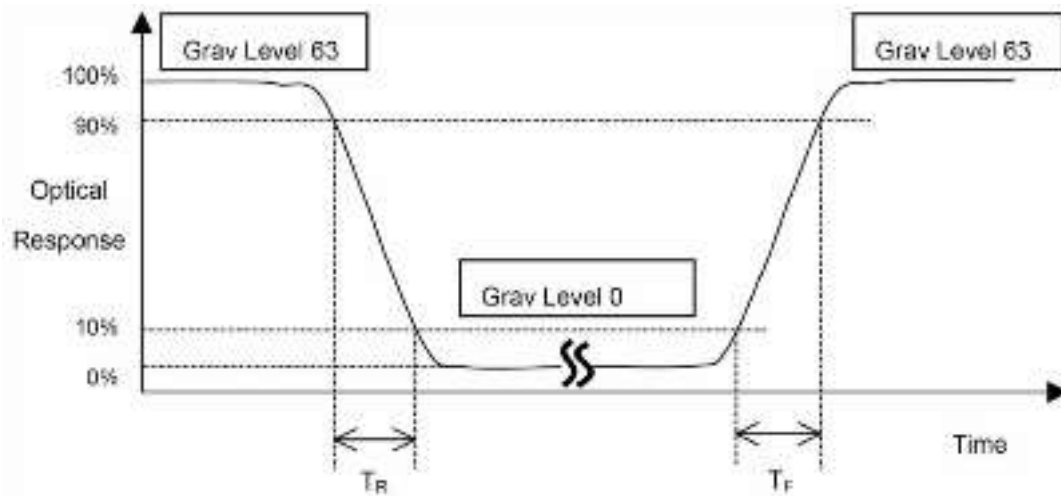

Figure 3

Note 3: Viewing Angle

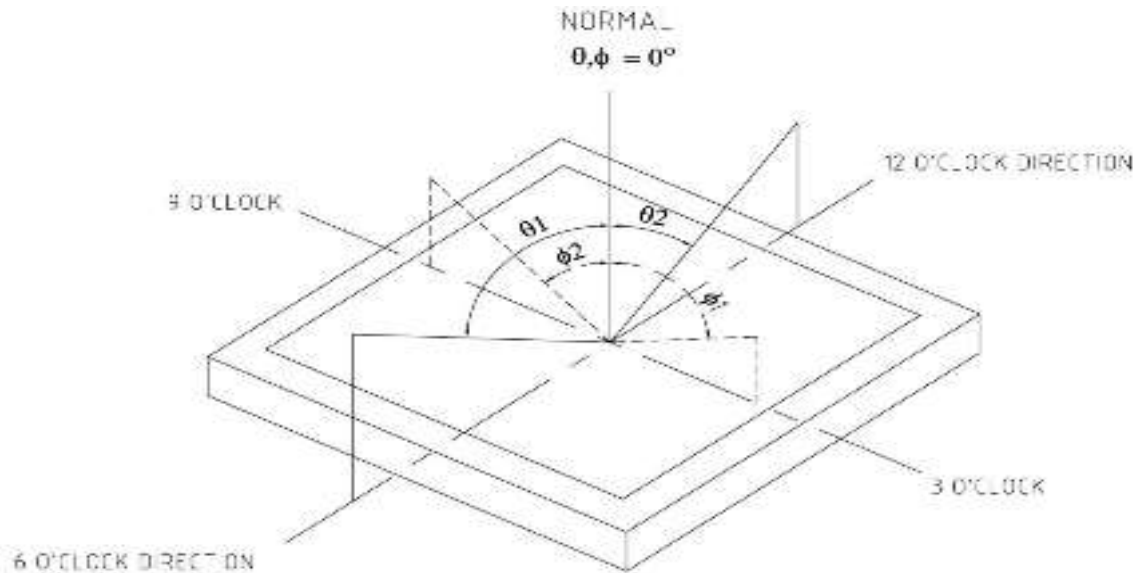

Figure 4

Note 4: Measurement Set-Up:

The LCD module should be stabilized at a given temperature for 20 minutes to avoid abrupt temperature change during measuring. In order to stabilize the luminance, the measurement should be executed after lighting Backlight for 20 minutes in a windless room.

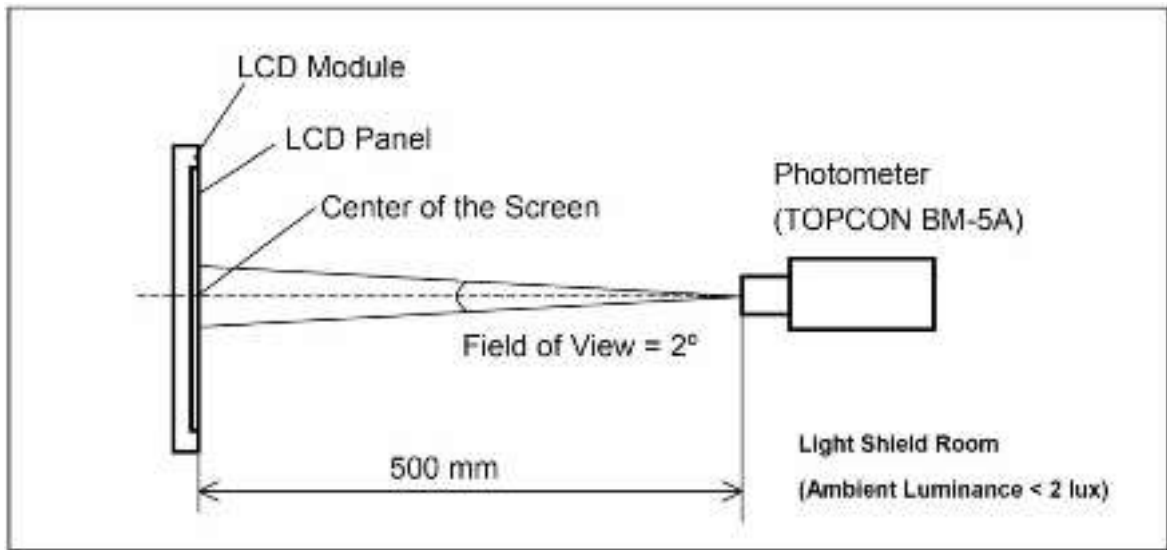

Figure 5



8. Timing Characteristics

8.1 DSI-MIPI Interface Timing Characteristics of IC

Table 8: Normal Write Mode (VCC = IOVCC=2.4~3.3V)

7.3.5.1. High speed mode

Parameter	Symbol	Parameter	Specification			Unit
			MIN	TYP	MAX	
High Speed mode						
DSI-CLK+/-	$2 \times UI_{INST}$	Double UI instantaneous	4	-	25	ns
DSI-CLK+/-	$UI_{INST} + UI_{INST}$	UI instantaneous Halfs	2	-	12.5	ns
DSI-Dn+/-	t_{DS}	Data to clock setup time	0.15	-	-	UI
DSI-Dn+/-	t_{DH}	Data to clock hold time	0.15	-	-	UI
DSI-CLK+/-	$t_{DRISCLK}$	Differential rise time for clock	150	-	0.3UI	ps
DSI-Dn+/-	$t_{DRISDATA}$	Differential rise time for data	150	-	0.3UI	ps
DSI-CLK+/-	$t_{DFALLCLK}$	Differential fall time for clock	150	-	0.3UI	ps
DSI-Dn+/-	$t_{DFALLDATA}$	Differential fall time for data	150	-	0.3UI	ps

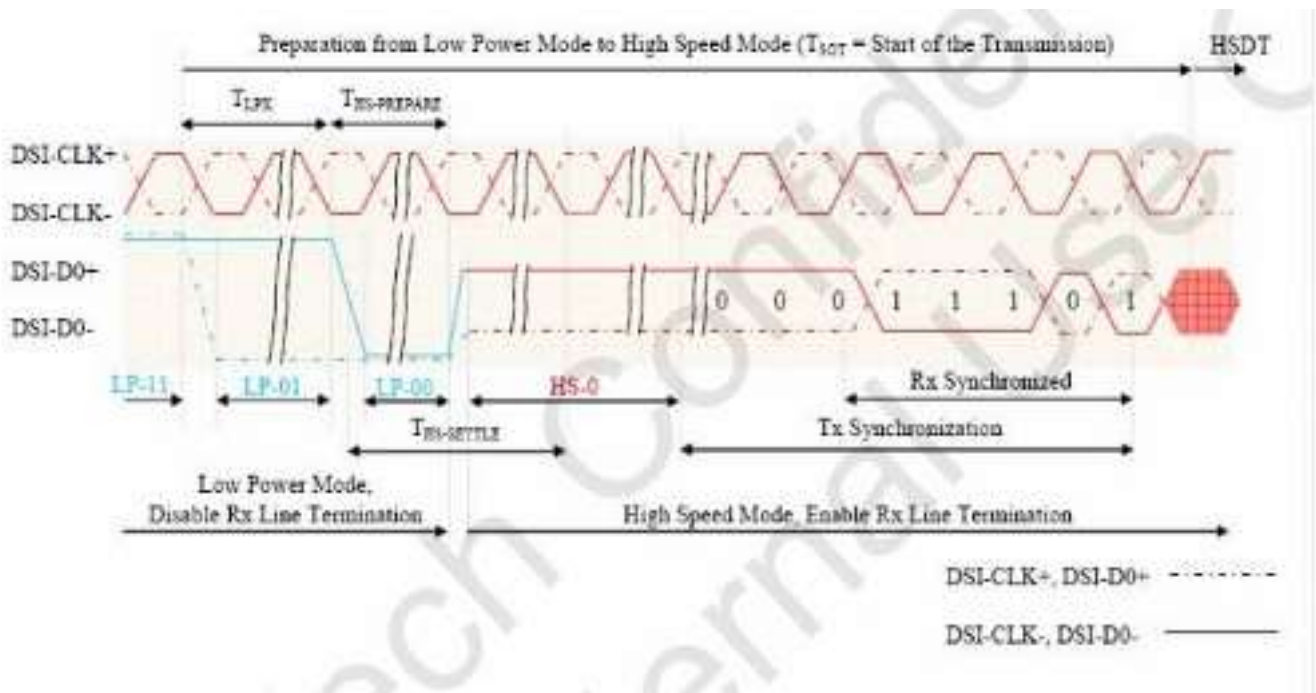

Figure 7. DSI-MIPI Timing



8.2 Reset Operation of IC

Table 9: Reset Timing Characteristics (VCC = IOVCC=2.4~3.3V)

Item	Symbol	Unit	Min.	Typ.	Max.
Reset low-level width	tRES	ms	1	-	-
Reset rise time	trRES	μs	-	-	10

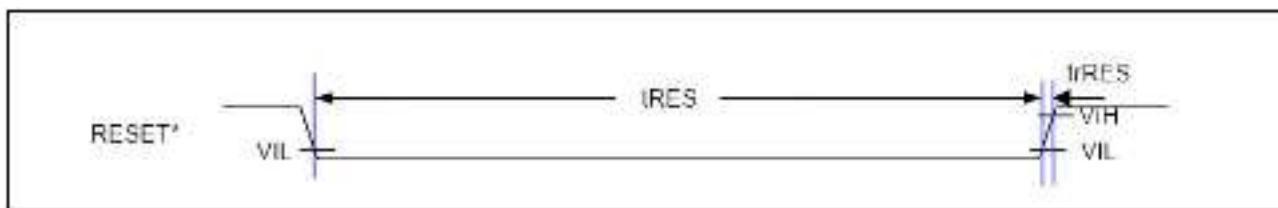

Figure 8: Reset Timing

9. Reliability Test Item

Test Item	Sample Type	Test Condition	Test result determinant gist
High temperature storage	Normal temperature	70±3°C;96H	the inspection of appearance and function character.
Low temperature storage	Normal temperature	-30±3°C;120H	
High temperature /humidity storage	Normal temperature	50°C±3°C,90%±3%RH;96H	
High temperature operation	Normal temperature	60±3°C;96H	
Low temperature operation	Normal temperature	-20±3°C;96H	
Temperature Shock	Normal temperature	-20±3°C,30min→60°C,30min;10cycle	

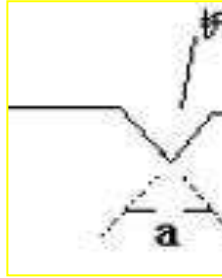

9.1 特殊检验要求:

检查项目	可接受标准	备注
背光	1. 无背光不接受 2. 亮度, 均匀度及功耗须在 SPEC 之内 3. 颜色坐标需在规格内或依据限度 4. 非背光框变形的漏光在玻璃外缘可以接受	目视检查/放大镜
铁壳	任何明显可见的损坏、变形和其它铁壳上有锡渣不可接受	
FPC	1. 变形和折痕标准如图所示, 两条折痕的角度不能超过 90° 2. 补强板裂、破损、外来材料和气泡的面积, 如果超过补强板的 $1/5$ 不能接受 3. 金手指部位有明显划伤、污点和外来细小指针状的异物都不可接受 4. 金手指氧化或者电镀不良不可以接受 5. pad 脱落或者断裂不可接受	

TFT 亮点、暗点

项目	点大小	允许数量
亮点、彩点	$0.2 < \Phi$	$N \leq 0$
	$0.1 < \Phi \leq 0.2$	$N \leq 2$
	$\Phi \leq 0.1$	不计
暗点	$0.2 < \Phi$	$N \leq 0$
	$0.1 < \Phi \leq 0.2$	$N \leq 2$
	$\Phi \leq 0.1$	不计
点与点距离	$d \geq 10\text{mm}$ (0.1-0.2的点之间)	

TP 外观判定标准 (可量化的缺陷按下表, 不可量化的参照样板)

项次	检验项目	检验判定标准			检验方法/设备	备注	缺陷等级		
							Z	A	B
污点、圆形杂物点 (注: 不包括摄像孔) 同色	大小: $\phi = (A+B)/2$ 	区域	点大小	数量及间距	目视				
			$\Phi \leq 0.1\text{mm}$	不计 (不可密集)					V
			$0.1 < \Phi \leq 0.2$	$N \leq 2, d \geq 10\text{mm}$					V
			$\Phi > 0.2$	不允许					V
污点、圆形	大小: $\phi =$		点大小	量及间距					



杂物点 (注: 不包括摄像孔) 异色		区域	$\Phi \leq 0.1\text{mm}$	不计 (不可密集)	菲林卡			V
			$0.1 < \Phi \leq 0.2$	$N \leq 2$ 个				V
			$\Phi > 0.2$	不允许, $d \geq 10\text{mm}$				V
线状杂物, 刮花 (注: 不包括摄像孔)		区域	宽 (W)	长 (L) 间距	目视			
			$W \leq 0.01\text{mm}$	不计				V
			$0.01 < W \leq 0.03$	$L \leq 3\text{mm}, N \leq 2$	菲林卡			V
			$0.03 < W \leq 0.05$	$L \leq 2\text{mm}, N \leq 1$				V
			$0.05 < W$	$N = 0$		V		
			触摸不能有手感			V		
气泡、凹痕、鱼眼 (注: 不包括摄像孔)	大小: $\phi = (A+B)/2$ 	区域	点大小	数量及间距				
			$\Phi \leq 0.1\text{mm}$	不计				V
			$0.1 < \Phi \leq 0.2$	$N \leq 2, d \geq 10\text{mm}$				V
			$\Phi > 0.2$	不允许				V
							V	

崩边、裂纹		崩边大小	目视			
		$X \leq 0.3\text{mm}$				V
		$Y \leq 0.2\text{mm}$				V
		$Z \leq T$ (T=玻璃厚度) (FPC 凹槽边距离 10mm 处 $Z < T/2$)				V
		崩边大小	菲林卡			
		$X \leq 0.3\text{mm}$				V
		$Y \leq 0.3\text{mm}$				V
		$Z \leq T$ (T=玻璃厚度) (FPC 凹槽边距离 10mm 处 $Z < T/2$)				V
		裂纹				
		不允许		V		
FPC 断裂不能超过 FPC 金属指长度的 1/3				V		



10. Suggestions for using LCD modules

10.1 Handling of LCM

1. The LCD screen is made of glass. Don't give excessive external shock, or drop from a high place.
2. If the LCD screen is damaged and the liquid crystal leaks out, do not lick and swallow. When the liquid is attach to your hand, skin, cloth etc, wash it off by using soap and water thoroughly and immediately.
3. Don't apply excessive force on the surface of the LCM.
4. If the surface is contaminated ,clean it with soft cloth. If the LCM is severely contaminated , use Isopropyl alcohol/Ethyl alcohol to clean. Other solvents may damage the polarizer . The following solvents is especially prohibited: water , ketone Aromatic solvents etc.
5. Exercise care to minimize corrosion of the electrode. Corrosion of the electrodes is accelerated by water droplets, moisture condensation or a current flow in a high-humidity environment.
6. Install the LCD Module by using the mounting holes. When mounting the LCD module make sure it is free of twisting, warping and distortion. In particular, do not forcibly pull or bend the I/O cable or the backlight cable.
7. Don't disassemble the LCM.
8. To prevent destruction of the elements by static electricity, be careful to maintain an optimum work environment.
 - Be sure to ground the body when handling the LCD modules.
 - Tools required for assembling, such as soldering irons, must be properly grounded.
 - To reduce the amount of static electricity generated, do not conduct assembling and other work under dry conditions.
 - The LCD module is coated with a film to protect the display surface. Exercise care when peeling off this protective film since static electricity may be generated.
9. Do not alter, modify or change the the shape of the tab on the metal frame.
10. Do not make extra holes on the printed circuit board, modify its shape or change the positions of components to be attached.
11. Do not damage or modify the pattern writing on the printed circuit board.
12. Absolutely do not modify the zebra rubber strip (conductive rubber) or heat seal connector
13. Except for soldering the interface, do not make any alterations or modifications with a soldering iron.
14. Do not drop, bend or twist LCM.

10.2 Storage

1. Store in an ambient temperature of 5 to 45。 C, and in a relative humidity of 40% to 60%. Don't expose to sunlight or fluorescent light.
2. Storage in a clean environment, free from dust, active gas, and solvent.
3. Store in antistatic container.



11. Packing (Reference only)

Packing Method

