



SPECIFICATION FOR TFT LCD MODULE

CUSTOMER : _____

CUSTOMER MODULE : _____

HL MODEL : HG062WV006

Preliminary Specification

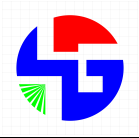
Final Specification

Customer Confirmation column:

Approved by : _____ Dept. : _____ Data : _____

Please return one of the copies of the specification with your signature to us within two weeks after you receive this document. If it is not returned, we will assume that you agree to the entire contents of this specification document.

Designed by	Checked by	Approved by



Contents		
NO.	Contents	Page
---	Cover	1
---	Contents	2
---	Document Revision History	3
一	General Description	4
二	Absolute Maximum Ratings	5
三	Optical Characteristics	6
四	Block Diagram	8
五	Interface Pin Connection	9
六	Electrical Characteristics	11
七	Reliability Test Items	16
八	Outline Dimension	17
九	Packing Form	18
十	General Precaution	19



Document Revision History				
Change No.	Date	Subject And Reason	Version No.	Responser
1	2020.06.29	New	01	WANG



1.0 General Description

1.1 Introduction

HannStar Display model is a color active matrix thin film transistor (TFT) liquid crystal display (LCD) that uses amorphous silicon TFT as a switching device. This model is composed of a TFT LCD panel and a driving circuit. This TFT LCD has a 6.2 (16:9) inch diagonally measured active display area with 800 horizontal by 480 vertical pixel resolutions.

1.2. Features

6.2 (16:9 diagonal) inch configuration

6 bits + FRC driver with 1channel TTL interface

Up/Down, Left/Right reversion selection

RoHS/ Halogen Free Compliance

1.3. General information

Item	Specification	Unit
Module size	155.2 (H) x 88.2 (V) x 5.0 (T)	
Outline Dimension	147(H) x 86.232 (V)	mm
Display area	137.52(H) x 77.232(V)	mm
Number of Pixel	800 RGB (H) x 480 (V)	pixels
Pixel pitch	0.1719(H) x 0.1609(V)	mm
Pixel arrangement	RGB Vertical stripe	
Display mode	Normally white	



2.0 Absolute Maximum Ratings

2.1 Electrical Absolute Rating

2.1.1 TFT LCD Module

Item	Symbol	Min.	Max.	Unit	Note
Power supply voltage	Vcc	-0.3	6.0	V	GND=0
	VGH	-0.3	40	V	GND=0
	VGL	-20	0.3	V	GND=0
	AVDD	-0.5	15	V	AGND=0
	VCOM	0	6	V	
Logic Signal Input Level	VI	-0.3	Vcc +0.3	V	

Note

- (1) Permanent damage may occur to the LCD module if beyond this specification. Functional operation should be restricted to the conditions described under normal operating conditions.
- (2) Ta =25+/-2°C

* 2.2 Environment Absolute Rating

Item	Symbol	Min.	Max.	Unit	Note
Operating Temperature	Topa	-20	70	°C	
Storage Temperature	Tstg	-30	80	°C	

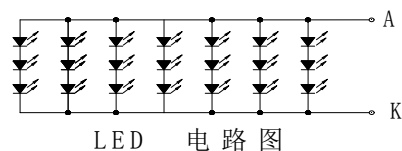
2.3 Back-light Unit:

PARAMETER	Sym.	Min.	Typ.	Max.	Unit	Test Condition	Note
LED Current	IF	-	210	-	mA	-	-
LED Voltage (Total)	V	16.8	17.1	17.4	V	-	-
Luminous instensity	IV	950	1000		Cd/m2		
Life Time		-	20000	-	Hr.	I ≤ 210mA	-
Color	White						

Note (1) Permanent damage may occur to the LCD module if beyond this specification. Functional operation should be restricted to the conditions described under normal operating conditions.

(2) Ta=25±2°C

(3) Test condition: LED Current 210mA





3.0 Optical Characteristics

3.1 Optical specification

3.1 Optical specification

Item	Symbol	Condition	Min.	Typ.	Max.	Unit	Note	
Contrast	CR	$\Theta=0$ Normal viewing angle	480	600	—		(1)(2)	
Response time	Rising		T_R	—	2	4	msec	(1)(3)
	Falling		T_F	—	6	12		
White luminance (Center)	Y_L					—		(1)(4) ($I_L=140mA$)
Color chromaticity (CIE1931)	White	W_x	0.260	0.310	0.360		(1)(4)	
		W_y	0.280	0.330	0.380			
Viewing angle	Hor.	Θ_L	65	75	—			
		Θ_R	65	75	—			
	Ver.	Θ_U	60	70	—			
		Θ_D	60	70	—			
Optima View Direction	6 O' clock						(5)	

3.2 Measuring Condition

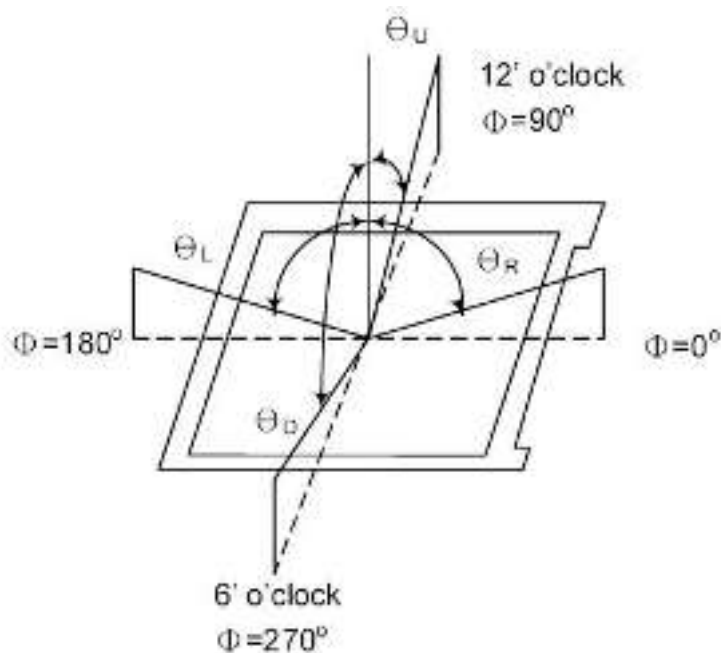
- Measuring surrounding: dark room
- LED current I_L : 120 mA
- Ambient temperature: $25\pm 2^\circ C$
- 15min. warm-up time.

3.3 Measuring Equipment

- FPM520 of Westar Display technologies, INC., which utilized SR-3 for Chromaticity and BM-5A for other optical characteristics.
- Measuring spot size: 20 – 21 mm



Note (1) Definition of Viewing Angle :

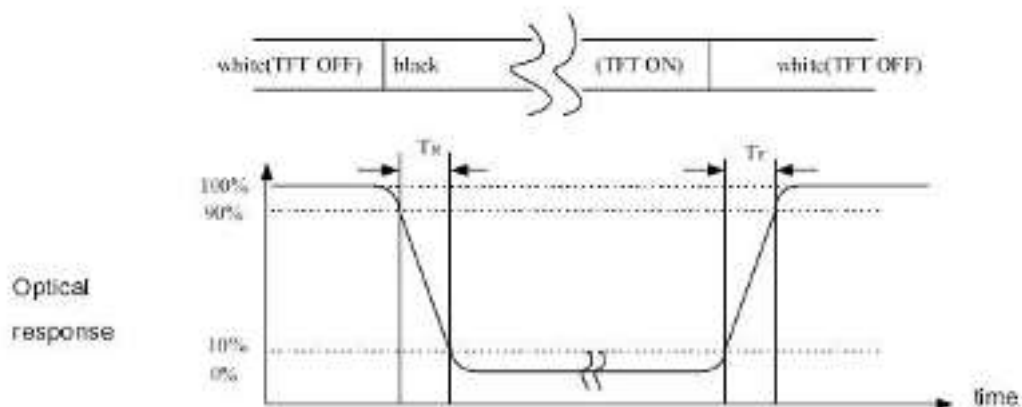


Note (2) Definition of Contrast Ratio(CR) :

measured at the center point of panel

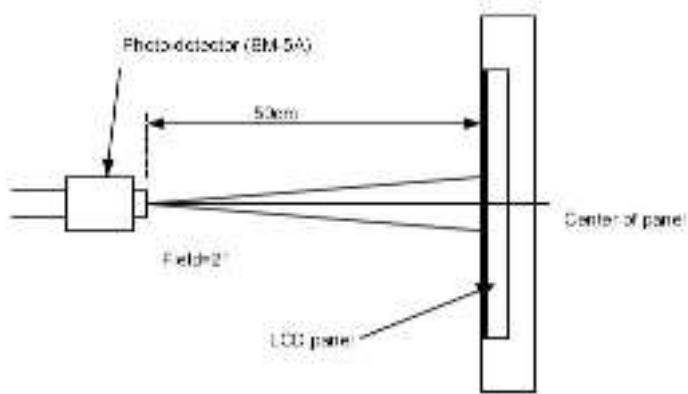
$$CR = \frac{\text{Luminance with all pixels white}}{\text{Luminance with all pixels black}}$$

Note (3) Definition of Response Time : Sum of T_R and T_F

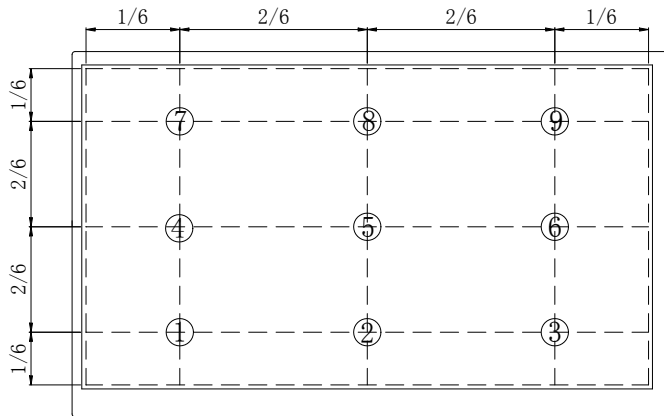




Note (4) Definition of optical measurement setup

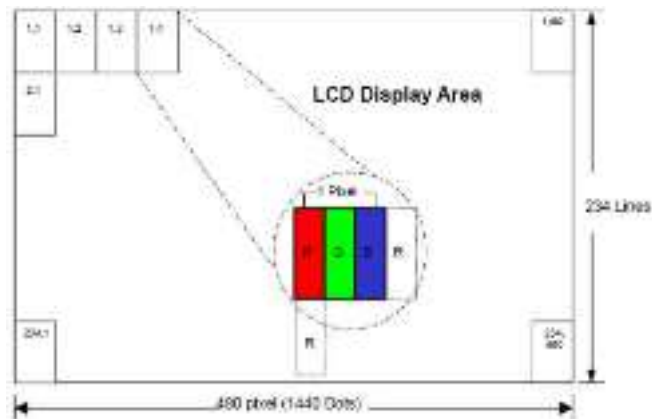


Note (5) Definition of brightness uniformity



4.0 Block Diagram

4.1 TFT-LCD Module





5.0 Interface Pin Conn

5.1 TFT LCD Module

CN2 (Input signal): FPC Down Connector, (FH28-60S-0.5SH (HIROSE), 60pin,pitch = 0.5mm)

Terminal no.	Symbol	I/O	Function
1	AGND	P	Analog Ground
2	AVDD	P	Analog Power
3	VCC	P	Digital Power
4	R0	I	Data Input(LSB)
5	R1	I	Data Input
6	R2	I	Data Input
7	R3	I	Data Input
8	R4	I	Data Input
9	R5	I	Data Input
10	R6	I	Data Input
11	R7	I	Data Input(MSB)
12	G0	I	Data Input(LSB)
13	G1	I	Data Input
14	G2	I	Data Input
15	G3	I	Data Input
16	G4	I	Data Input
17	G5	I	Data Input
18	G6	I	Data Input
19	G7	I	Data Input(MSB)
20	B0	I	Data Input(LSB)
21	B1	I	Data Input
22	B2	I	Data Input
23	B3	I	Data Input
24	B4	I	Data Input
25	B5	I	Data Input
26	B6	I	Data Input
27	B7	I	Data Input(MSB)
28	DCLK	I	Clock input
29	DE	I	Data Enable signal
30	HSD	I	Horizontal sync input.Negative polarity
31	VSD	I	Vertical sync input.Negative polarity
32	MODE3	I	DE/SYNC mode select .normally pull high H:DE mode.L:HSD/VSD mode
33	RSTB	I	global reset pin.Active low to enter reset state.suggest to connecting with an RC reset circuit for stability .normally pull high.
34	STBYB	I	standby mode,normally pull high STBYB="1",normal operation STBYB="0",timming control ,source driver will turn off,all output are high-Z
35	SHLR	I	Source right or left sequence control.SHLR="L",shift left:last data=S1<-S2...S1200=first data SHLR="H",shift right:first data=S1->SS2...S1200=last data



Terminal no.	Symbol	I/O	Function
36	VCC	P	Digital Power
37	UPDN	I	gate up or down scan control. UPDN="L", DOWN shift : G1->G2...->G480 ; UPDN="H", up shift: G1<-G2...<-G480
38	GND	P	Digital Ground
39	AGND	P	Analog Ground
40	AVDD	P	Analog Power
41	VCOMin	I	For external VCOM DC input (Adjustable)
42	DITH	I	Dithering setting: DITH="H" 6bit resolution (last 2 bits of input data truncated) (default setting) DITH="L" 8bit resolution
43	NC	-	Not connect For Test
44	NC	-	Not connect
45	V10	P	Gamma correction voltage reference
46	V9	P	Gamma correction voltage reference
47	V8	P	Gamma correction voltage reference
48	V7	P	Gamma correction voltage reference
49	V6	P	Gamma correction voltage reference
50	V5	P	Gamma correction voltage reference
51	V4	P	Gamma correction voltage reference
52	V3	P	Gamma correction voltage reference
53	V2	P	Gamma correction voltage reference
54	V1	P	Gamma correction voltage reference
55	NC	-	Not connect
56	VGH	P	Positive Power for TFT
57	VCC	P	Digital Power
58	VGL	P	Negative Power for TFT
59	GND	P	Digital Ground
60	NC	-	Not connect



6. Electrical Characteristics

6.1 TFT LCD Module

Item	Symbol	Min.	Typ.	Max.	Unit	Note
Supply Voltage	V _{CC}	3.0	3.3	3.6	V	
	V _{OH}	12	15	23	V	
	V _{OL}	-12	-7	-5	V	
	AV _{DD}	9.9	10	10.1	V	
VCOM	VCOMin	-	3.4	-	V	
Input signal voltage	V _H	0.7 V _{CC}	-	V _{CC}	V	Note (1)
	V _L	0	-	0.3 V _{CC}	V	
Current of power supply	I _{DD}	-	12.37	-	mA	V _{CC} =3.3V
	I _{DD}	-	13.599	-	mA	AV _{DD} =10 V (Black)
	I _{OH}	-	0.099	-	mA	V _{OH} =15V
	I _{OL}	-	0.371	-	mA	V _{OL} = -7V
Input level of V1-V5	V _X	AVDD/2-		AVDD-0.1-	V	
Input level of V6-V10	V _X	0.1-		AVDD/2-	V	

Note (1): HSYNC, VSYNC, DE, Digital Data

Note (2): Be sure to apply the power voltage as the power sequence spec.

Note (3): DGND=AGND=0V.)

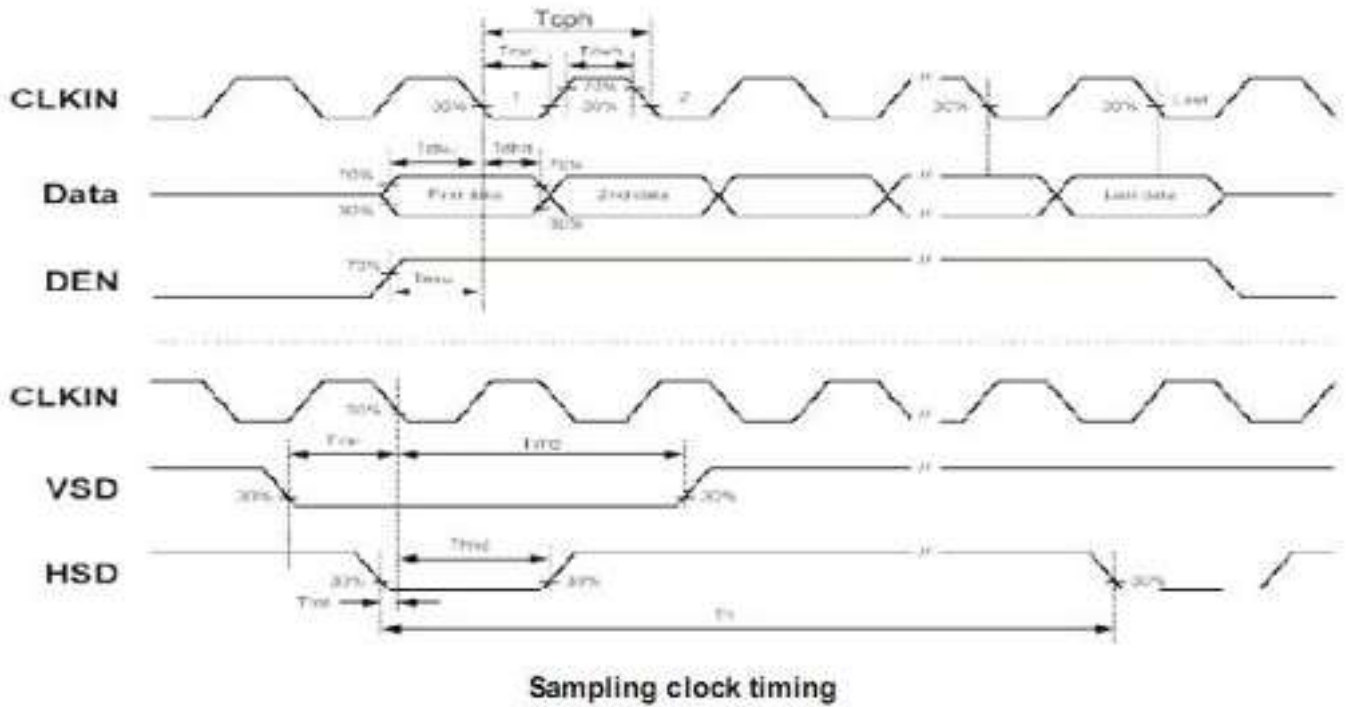


6.2 AC Characteristics

Item	Symbol	Min.	Typ.	Max.	Unit	Note
DCLK cycle time	Tcph	25			ns	
DCLK frequency	fcclk		30	40	MHz	
DCLK pulse duty	Tcwh	40	50	60	%	
VSD setup time	Tvst	8			ns	
VSD hold time	Tvhd	8			ns	
HSD setup time	Thst	8			ns	
HSD hold time	Thhd	8			ns	
Data setup time	Tdsu	8			ns	
Data hold time	Tdhd	8			ns	
DE setup time	Tesu	8			ns	
DE hold time	Tehd	8			ns	
Horizontal display area	thd		800		Tcph	
HSD period time	th		928		Tcph	
HSD pulse width	thpw	1	48		Tcph	
HSD back porch	thb		88		Tcph	
HSD front porch	thfp		40		Tcph	
Vertical display area	tvd		480		th	
VSD period time	tv		525		th	
VSD pulse width	tvpw		3		th	
VSD back porch	tvb		32		th	
VSD front porch	tvfp		13		th	

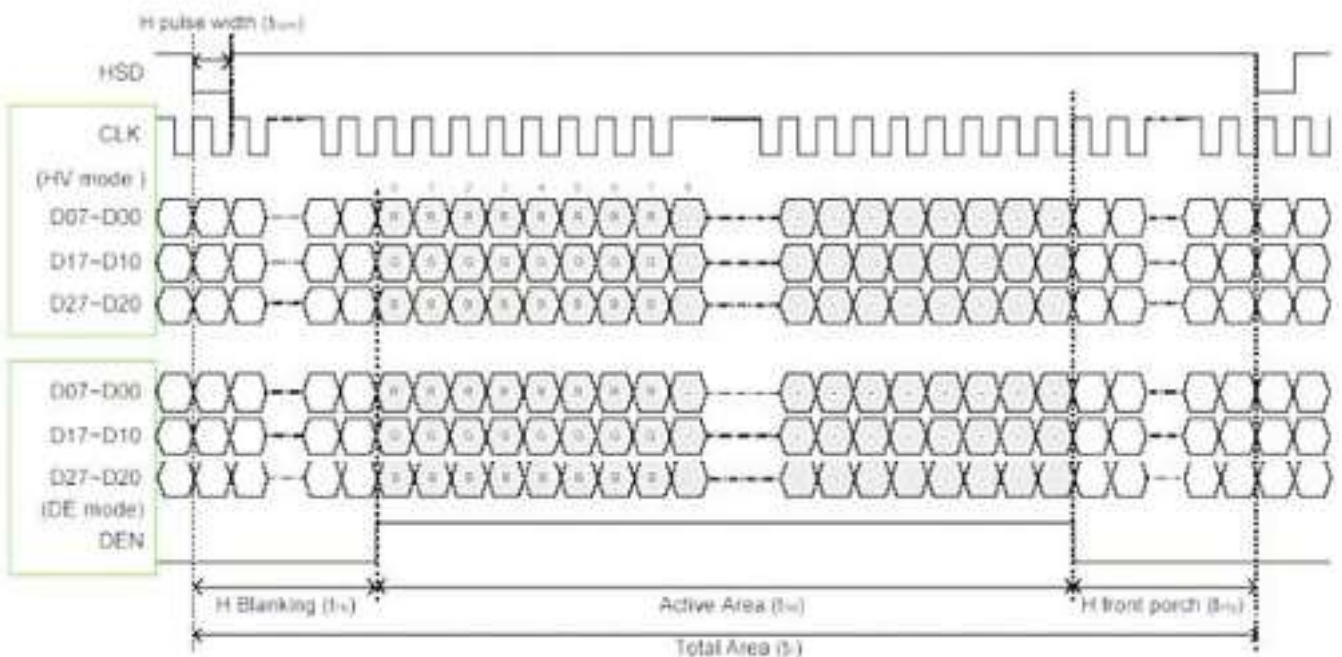


Diagram of Interface Signal



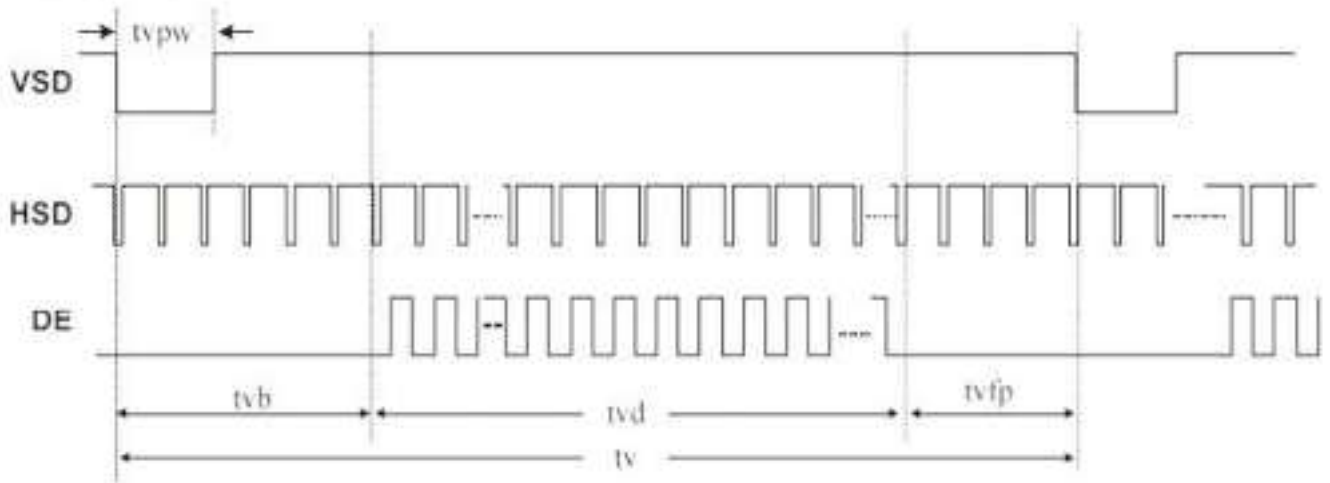
Sampling clock timing

Horizontal input timing





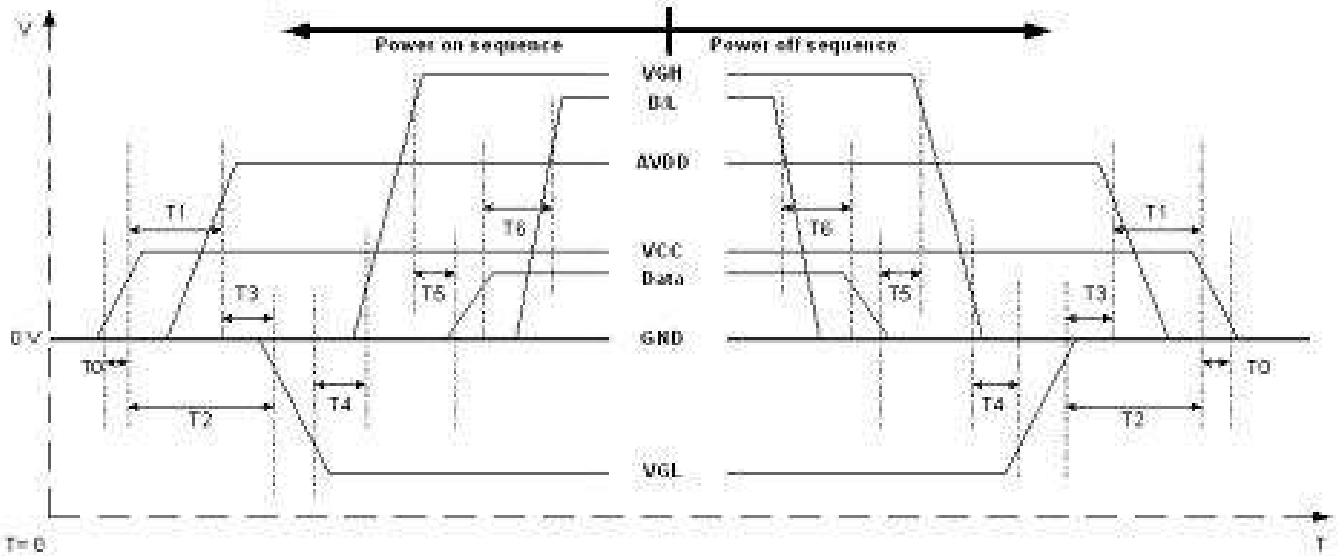
Vertical Input timing



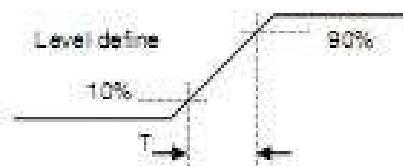
Vertical timing



6.4 Power Sequence



Item	Min.	Typ.	Max.	Unit
T0	0.5	--	20	msec
T1	16			msec
T2	20			msec
T3	0			msec
T4	20		--	msec
T5	20			msec
T6	50			msec



Power On Sequence: VCC-> AVDD -> VGL -> VGH -> Data -> B/L

Power Off Sequence: B/L-> Data -> VGH -> VGL -> AVDD -> VCC

Notes: Data include R0-R7, G0-G7, B0-B7, HSD, VSD, DCLK, SHLR, UPDN, DE MODE, RSTB, STBYB, SHLR, UPDN, DITH



5. Reliability test items

No	Test Item	Test condition	Criterion
1	High Temperature Storage	80°C±2°C 240H Restore 2H at 25°C Power off	1. After testing, cosmetic and electrical defects should not happen. 2. Total current consumption should not be more than twice of initial value.
2	Low Temperature Storage	-30°C±2°C 240H Restore 2H at 25°C Power off	
3	High Temperature Operation	70°C±2°C 240H Restore 2H at 25°C Power on	
4	Low Temperature Operation	-20°C±2°C 240H Restore 4H at 25°C Power on	
5	High Temperature/Humidity Operation	60°C±2°C 90%RH 240H Power on	
6	Temperature Cycle	-30°C —————> 80°C 30min 5min 30min after 5 cycle, Restore 2H at 25°C Power off	Not allowed cosmetic and electrical defects.
7	Vibration Test	10Hz~150Hz, 100m/s ² , 120min	
8	Shock Test	Half- sine wave, 300m/s ² , 11ms	
9	ESD Test	Air discharge: +/-8KV, Contact discharge: 4KV	

Note 1: Ta is the ambient temperature of samples.

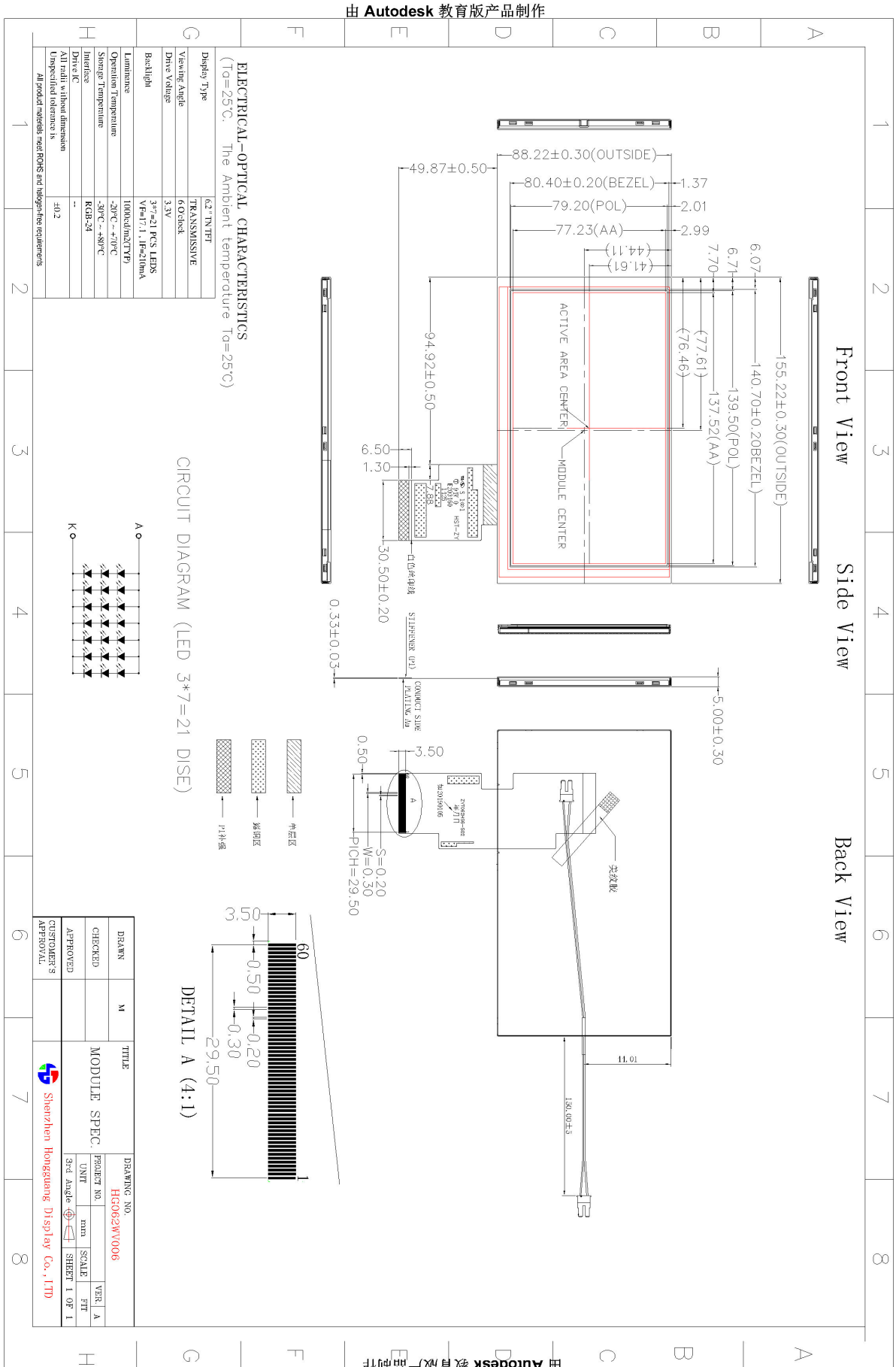
Note 2: Ts is the temperature of panel' s surface.

Note 3: In the standard condition, there shall be no practical problem that may affect display function. After the reliability test, the product only guarantees operation

Note 4: Before cosmetic and function test, the product must have enough recovery time, at least 2 hours at room temperature.

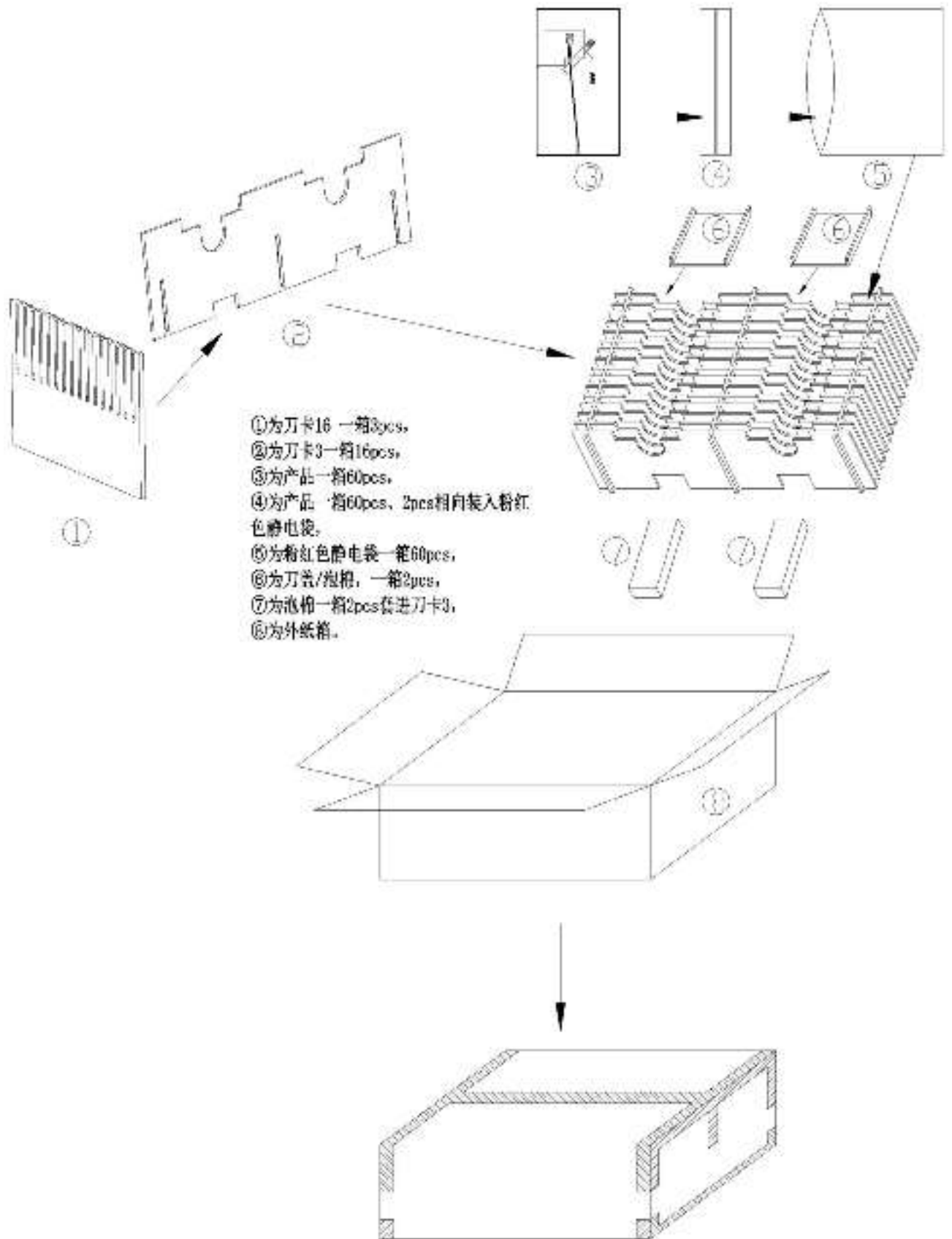


6.0 Outline dimension





9.0 Packing form





10.0 General Precaution

10.1 Use Restriction

This product is not authorized for use in life supporting systems, aircraft navigation control systems, military systems and any other application where performance failure could be life-threatening or otherwise catastrophic.

10.2 Assembly Precaution

10.2.1 Please use the mounting hole on the module side in installing and do not bending or wrenching LCD in assembling. And please do not drop, bend or twist LCD module in handling.

10.2.2 Please design display housing in accordance with the following guide lines.

10.2.2.1 Housing case must be destined carefully so as not to put stresses on LCD all sides and not to wrench module. The stresses may cause non-uniformity even if there is no non-uniformity statically.

10.2.2.2 Keep sufficient clearance between LCD module back surface and housing when the LCD module is mounted. The clearance in the design is recommended taking into account the tolerance of LCD module thickness and mounting structure height on the housing.

10.2.3 Please do not push or scratch LCD panel surface with any-thing hard. And do not soil LCD panel surface by touching with bare hands. (Polarizer film, surface of LCD panel is easy to be flawed.)

10.2.4 Please do not press any parts on the rear side such as source IC, gate IC, and FPC during handling LCD module. If pressing rear part is unavoidable, handle the LCD module with care not to damage them.

10.2.5 Please wipe out LCD panel surface with absorbent cotton or soft cloth in case of it being soiled.

10.2.6 Please wipe out drops of adhesives like saliva and water on LCD panel surface immediately. They might damage to cause panel surface variation and color change.

10.2.7 Please do not take a LCD module to pieces and reconstruct it. Resolving and reconstructing modules may cause them not to work well.

10.3 Disassembling or Modification

Do not disassemble or modify the module. It may damage sensitive parts inside LCD module, and may cause scratches or dust on the display. HannStar does not warrant the module, if customers disassemble or modify the module.

10.4 Breakage of LCD Panel

10.4.1 If LCD panel is broken and liquid crystal spills out, do not ingest or inhale liquid crystal, and do not contact liquid crystal with skin.

10.4.2 If liquid crystal contacts mouth or eyes, rinse out with water immediately.

10.4.3 If liquid crystal contacts skin or cloths, wash it off immediately with alcohol and rinse thoroughly with water.

10.4.4 Handle carefully with chips of glass that may cause injury, when the glass is broken.

10.5 Absolute Maximum Ratings and Power Protection Circuit



10.5.1 Do not exceed the absolute maximum rating values, such as the supply voltage variation, input voltage variation, variation in parts' parameters, environmental temperature, etc., otherwise LCD module may be damaged.

10.5.2 Please do not leave LCD module in the environment of high humidity and high temperature for a long time.

10.5.3 It's recommended employing protection circuit for power supply.

10.6 Operation

10.6.1 Do not touch, push or rub the polarizer with anything harder than HB pencil lead. Use fingerstalls of soft gloves in order to keep clean display quality, when persons handle the LCD module for incoming inspection or assembly.

10.6.2 When the surface is dusty, please wipe gently with absorbent cotton or other soft material.

10.6.3 Wipe off saliva or water drops as soon as possible. If saliva or water drops contact with polarizer for a long time, they may causes deformation or color fading.

10.6.4 When cleaning the adhesives, please use absorbent cotton wetted with a little petroleum benzine or other adequate solvent.

10.7 Static Electricity

10.7.1 Protection film must remove very slowly from the surface of LCD module to prevent from electrostatic occurrence.

10.7.2 Because LCD module uses CMOS-IC on TFT-LCD panel, it is very weak to electrostatic discharge. Please be careful with electrostatic discharge.

10.7.3 Persons who handle the module should be grounded through adequate methods.

10.8 Disposal

When disposing LCD module, obey the local environmental regulations.

10.9 OTHERS

10.9.1 A strong incident light into LCD panel might cause display characteristics' changing inferior because of polarizer film, color filter, and other materials becoming inferior. Please do not expose LCD module direct sunlight land strong UV rays.

10.9.2 Please pay attention to a panel side of LCD module not to contact with other materials in preserving it alone.

10.9.3 For the packaging box, please pay attention to the followings:

10.9.3.1 Packaging box and inner case for LCD are designed to protect the LCDs from the damage or scratching during transportation. Please do not open except picking LCDs up from the box.

10.9.3.2 Please do not pile them up more than 6 boxes. (They are not designed so.) And please do not turn over.

10.9.3.3 Please handle packaging box with care not to give them sudden shock and vibrations. And also please do not throw them up.

10.9.3.4 Packing box and inner case for LCDs are made of cardboard. So please pay attention not to get them wet. (Such like keeping them in high humidity or wet place can occur getting them wet.)